

MODEL	FS5xx
ALIMENTAZIONE POWER	230V + T.
POTENZA INSTALLATA INSTALLED POWER RATING	1Kw
CORRENTE A PIENO CARICO FULL-LOAD CURRENT	
APPROVATO APPROVED	SA
DATA DATE	11-10-2012
	

FROMMM

Electrical drawing ELS.1071
 FROMM Model FS5xx.V03
 Serial Number 03.xxxx
 Articol Number / Client

Supplier:
 FROMM ITALIANA S.R.L. / Stretch Wrapping Division
 Via del Lavoro 21
 37013 Caprino V.s.e. (VR)/ ITALIA

Phone 0039 045 6245 577
 Fax 0039 045 6230 363

E-mail info@fromm-stretch.com
 Home Page: www.fromm-stretch.com

Dis. N.	LY00R00P00	Impianto	AWVOLGITORE A BRACCIO FS5xx WRAPPER MACHINE FS5xx	Ordine	FOGLIO
	CAD				
Nome File	LY00R00P00	Denominazione	COPERTINA COVER	Commissa	STG
Data	08/12/2012			Esecutore	SERVISI A.
					2

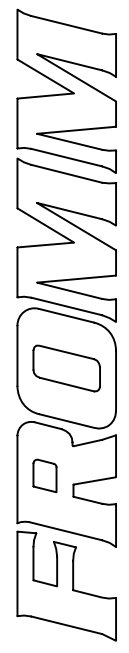

LISTA FOGLI \ INDEX

Foglio Sheet	Descrizione Description	Revisione \ Revision									Foglio Sheet	Descrizione Description	Revisione \ Revision									
		0	1	2	3	4	5	6	7	8			9	0	1	2	3	4	5	6	7	8
1	COPERTINA / COVER										25	COPERTINA C2 / C2 COVER										
2	INDEX / INDEX										66	CONNETTORE AUSILIARI CARRELLO / C2 CONNECT AUX										
3	ALIMENTAZIONE / POWER SUPPLY										70	LISTA MATERIALE / MATERIAL LIST										
4	ALIMENTAZIONE / POWER SUPPLY																					
5	ROTAZIONE TAVOLA / TABLE ROTATION																					
6	SALITA/DISCESA CARRELLO / CARRIAGE UP/DOWN																					
6A	PRESSORE MECCANICO / MECHANICAL PRESSURE																					
7	INGRESSI DIGITALI / DIGITAL INPUT																					
8	INGRESSI DIGITALI / DIGITAL INPUT																					
9	USCITE DIGITALI / DIGITAL OUTPUT																					
10	CONNETTORE CARRELLO / CONNECTOR CARRIAGE																					
10A	VISTA SCHEDA / PC BOARD																					
11	PANNELLO DI CONTROLLO / CONTROL PANEL																					
12	MORSETTIERA M1 / TERMINAL M1																					
13	COPERTINA C7 / C7 COVER																					
14	CONNETTORE AUSILIARI CARRELLO / CARRIAGE AUX CONNECTOR																					
15	MOTORE RULLO LENTO / LOW SPEED ROLLER MOTOR																					
16	MOTORE RULLO VELOCE / FAST SPEED ROLLER MOTOR																					
17	SCORTA / SPARE																					
18	COPERTINA C6 / C6 COVER																					
19	CONNETTORE AUSILIARI CARRELLO / CARRIAGE AUX CONNECTOR																					
20	MOTORE RULLO LENTO / LOW SPEED ROLLER MOTOR																					
21	SCORTA / SPARE																					
22	COPERTINA C4 / C4 COVER																					
23	CONNETTORE AUSILIARI CARRELLO / CARRIAGE AUX CONNECTOR																					
24	FRIZIONE ELETTROMAGNETICA / ELECTROMAGNETIC CLUTCH																					

Note :

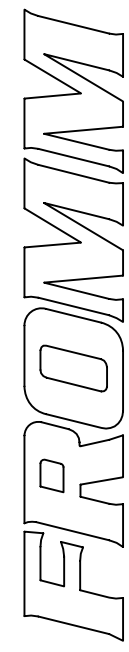

Dis. N.	LY00R00P00	Impianto	AWVOLGITORE A BRACCIO FS5xx WRAPPER MACHINE FS5xx
CAD	SPAC	Ordine	Commissa STD
Nome File	LY00R00P00	Denominazione	INDICE INDEX
Data	08/12/2012	Esecutore	SERVISI A.

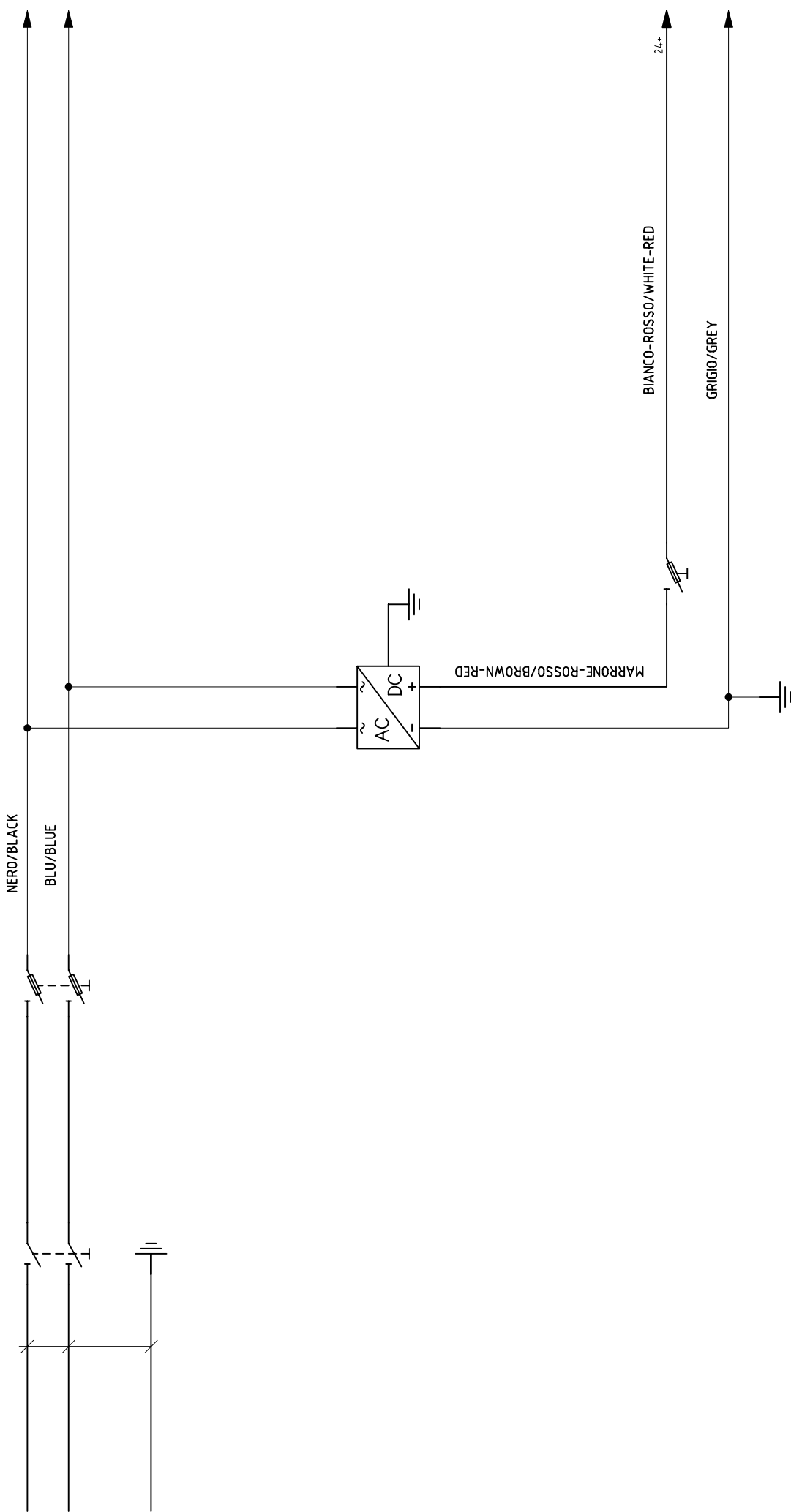

<h1 style="text-align: center;">FAROMM</h1>		Dis. N.	LY00R00P00	Impianto	AWVOLGITORE A BRACCIO FS5xx WRAPPER MACHINE FS5xx		Ordine	FOLGIO
		CAD	SPAC	Denominazione	ALIMENTAZIONE POWER SUPPLY		Commessa STD	3
		Nome File	LY00R00P00	Data	08/12/2012	Esecutore SERVISI A.		SEQUE
								4

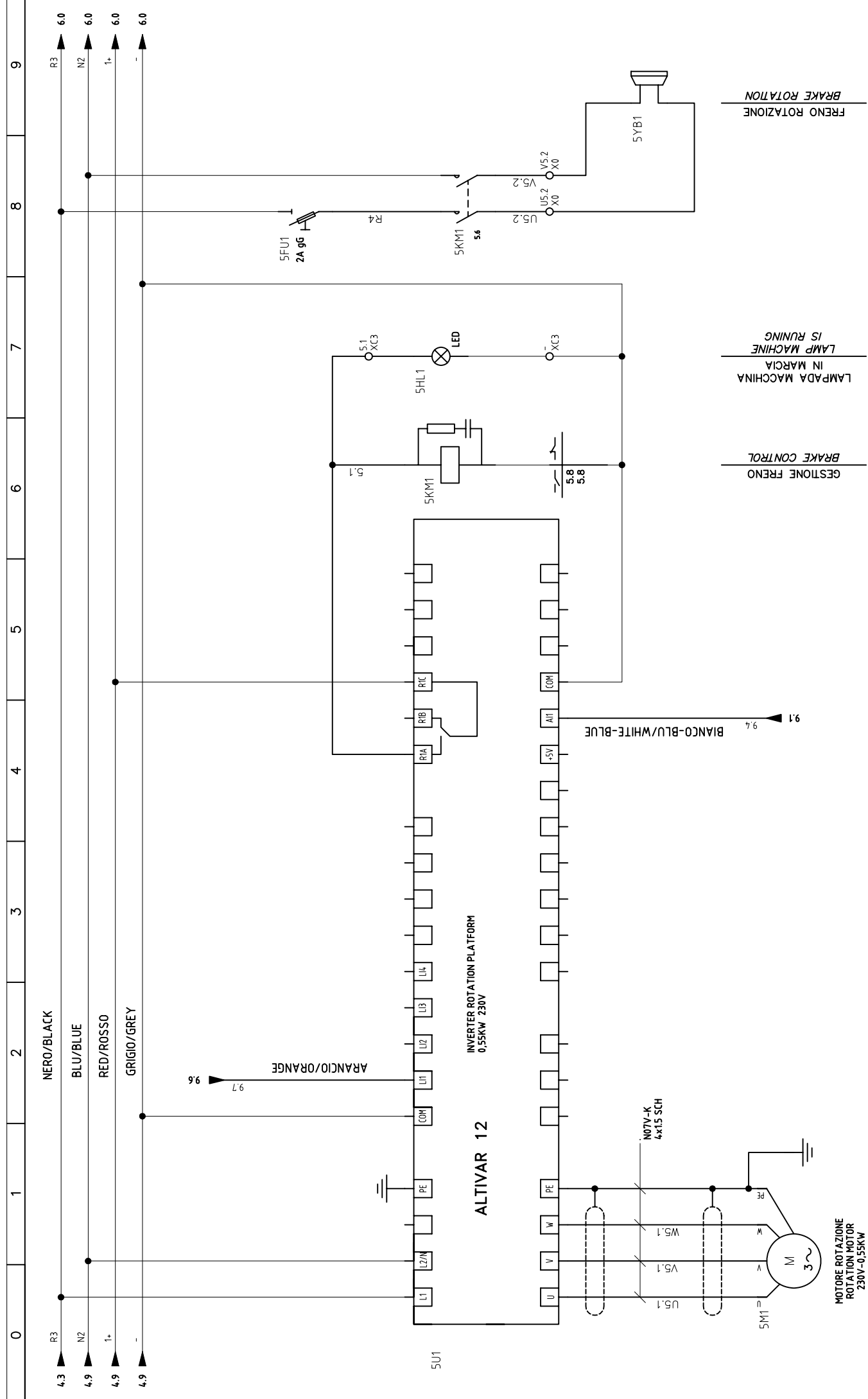

FROMM		Dis. N. LY00R00P00		Impianto		Ordine		FOGLIO	
		CAD SPAC	AWVOLGITORE A BRACCIO FS5xx WRAPPER MACHINE FS5xx		Commissa STD	5			
Nome File LY00R00P00		Denominazione		Esecutore		SEGUE		6	
Data 08/12/2012		ROTAZIONE BRACIO ARM ROTATION MOTOR		SERVISI A.					

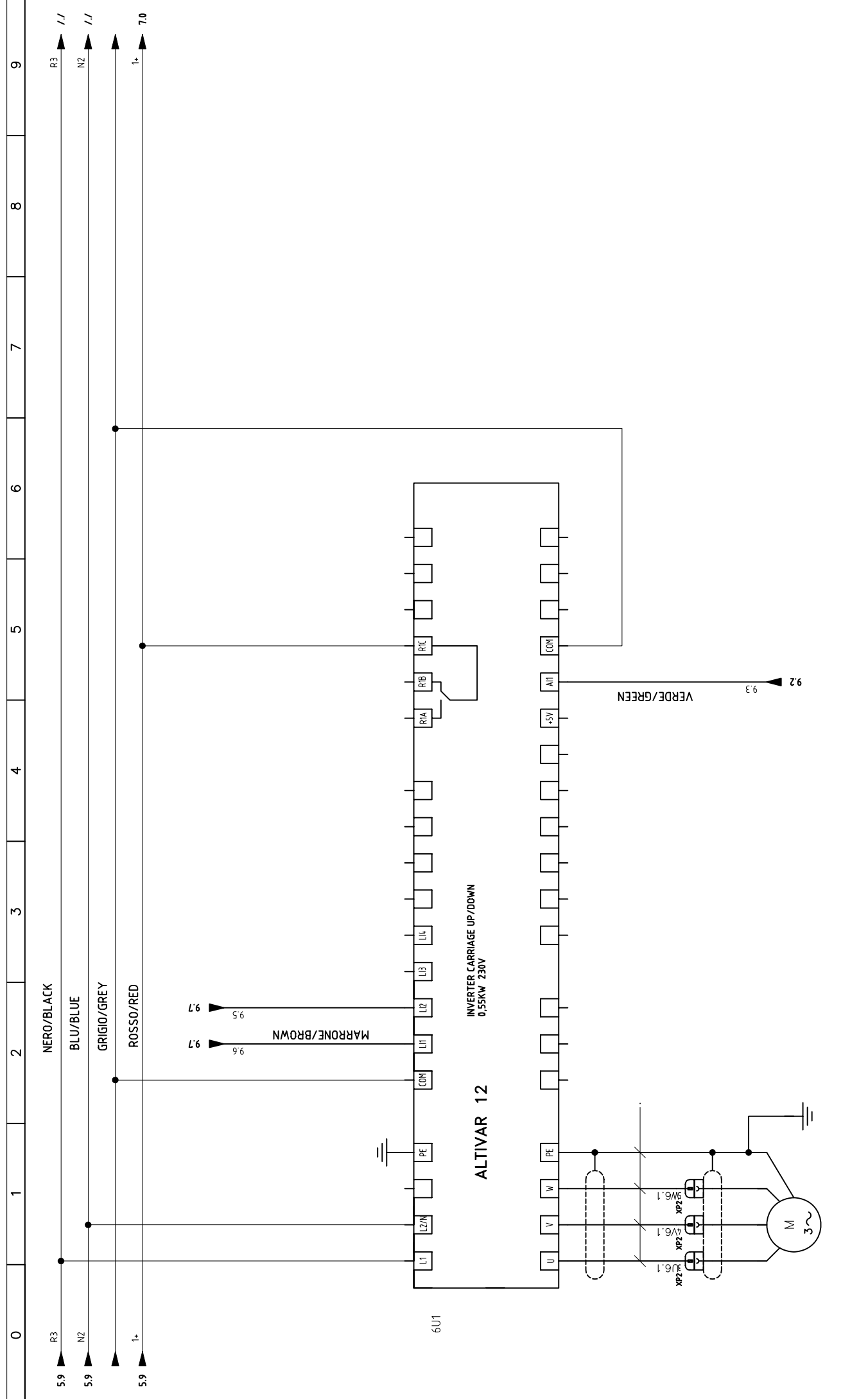

<h1 style="text-align: center;">FAROMM</h1>	Dis. N.	LY00R00P00	Impianto AWVOLGITORE A BRACCIO FS5xx WRAPPER MACHINE FS5xx Denominazione SALITA/DISCESA CARRELLO CARRIAGE UP/DOWN	Ordine Commessa STD Esecutore SERVIZI A.	FOGLIO	6
	CAD	SPAC			SEGUE	7
	Nome File	LY00R00P00				
	Data	08/12/2012				

Dis. N. LY00R00P00
 CAD SPAC
 Nome File LY00R00P00
 Data 08/12/2012

Impianto
 AWVOLGITORE A BRACCIO FS5xx
 WRAPPER MACHINE FS5xx

Denominazione
 INGRESSI DIGITALI
 DIGITAL INPUT

Ordine
 Commessa
 STD
 Esecutore
 SERVIZI A.

FOGLIO
 7
 SEQUE
 8

ALIMENTAZIONE SCHEDA 24VDC
 POWER SUPPLY 24VDC

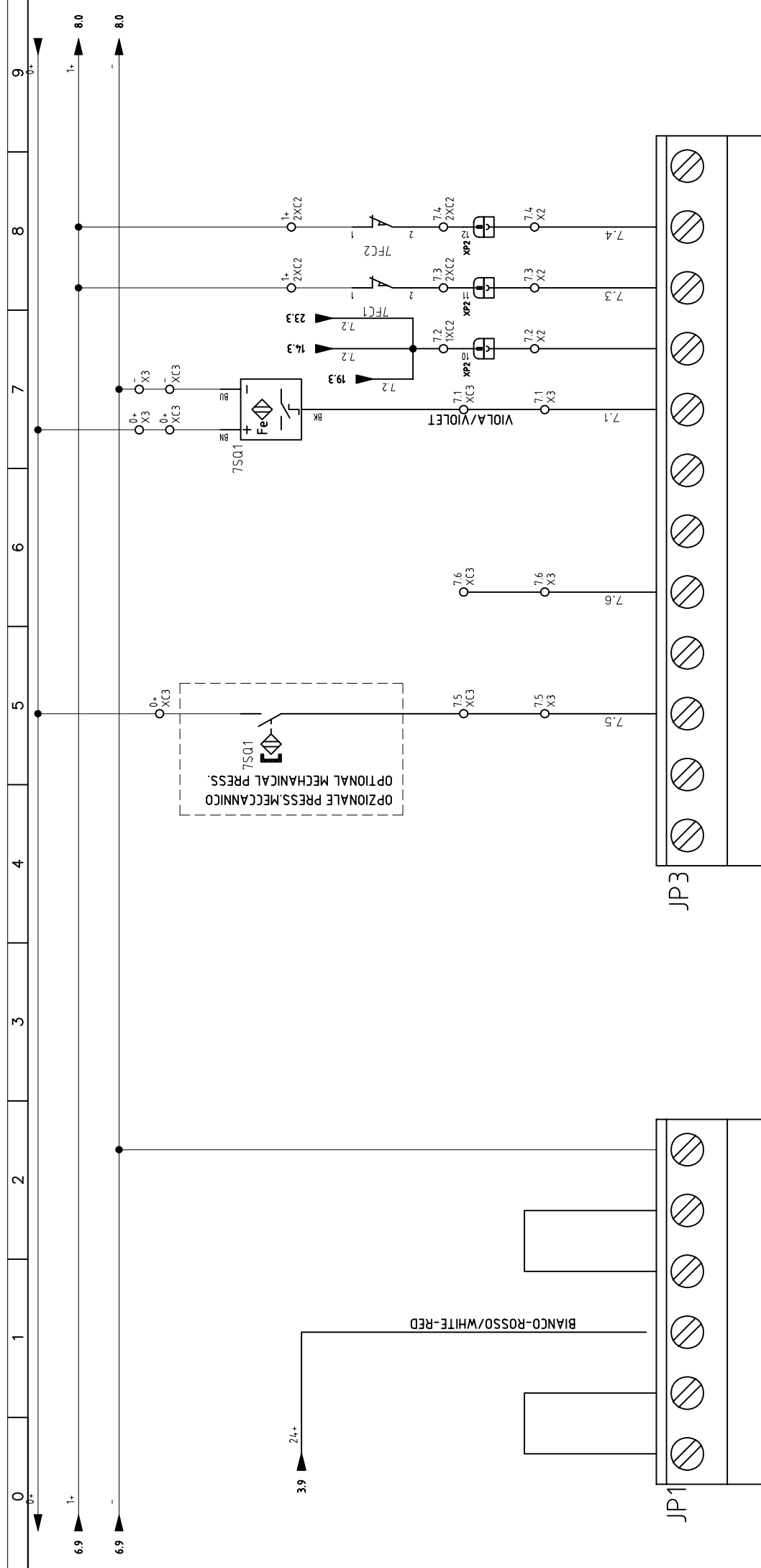
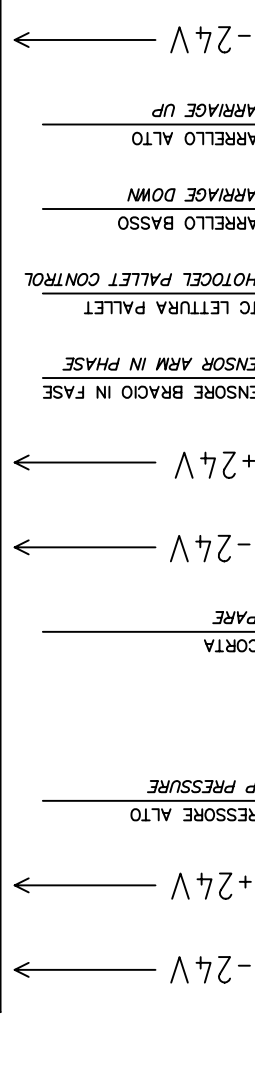
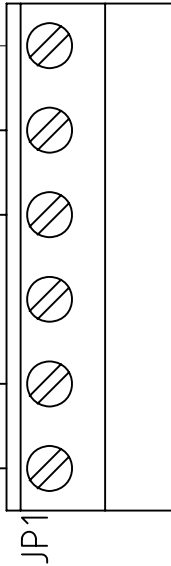

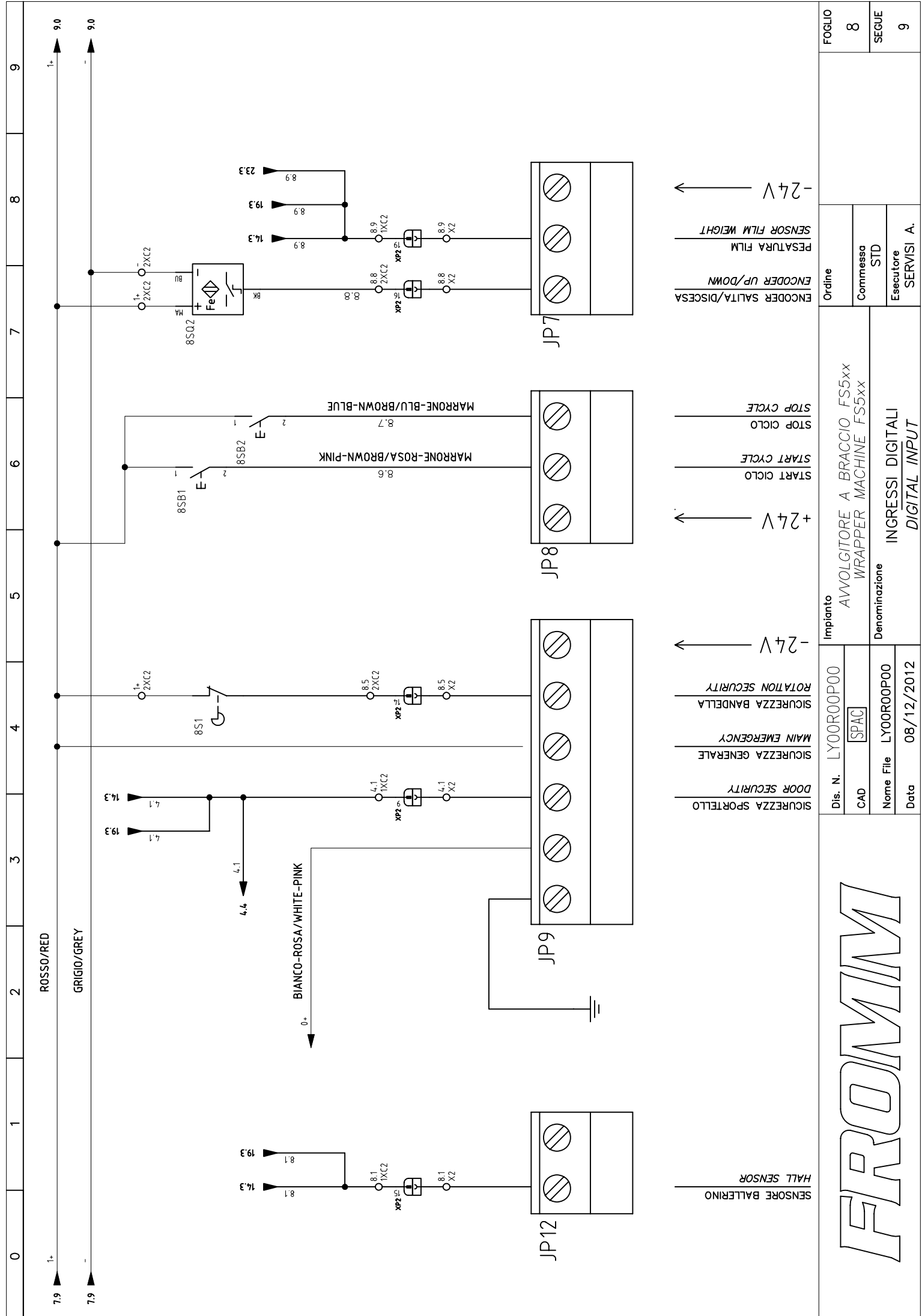

FAROM

Dis. N. LY00R00P00	Impianto AVVOLGITORE A BRACCIO FS5xx WRAPPER MACHINE FS5xx	FOGLIO 8	
CAD SPAC	Denominazione INGRESSI DIGITALI DIGITAL INPUT	Commissa STD	SEQUE 9
Nome File LY00R00P00	Data 08/12/2012	Esecutore SERVISI A.	

SENORE BALLERINO
HALL SENSOR

SICUREZZA SPORTELLO
SICUREZZA GENERALE
MAIN EMERGENCY
SICUREZZA BANDELLA
ROTATION SECURITY

-24V ←

← +24V

START CICLO
STOP CICLO

ENCODER SALITA/DISCESA
ENCODER UP/DOWN
PESATURA FILM
SENSOR FILM WEIGHT

← -24V

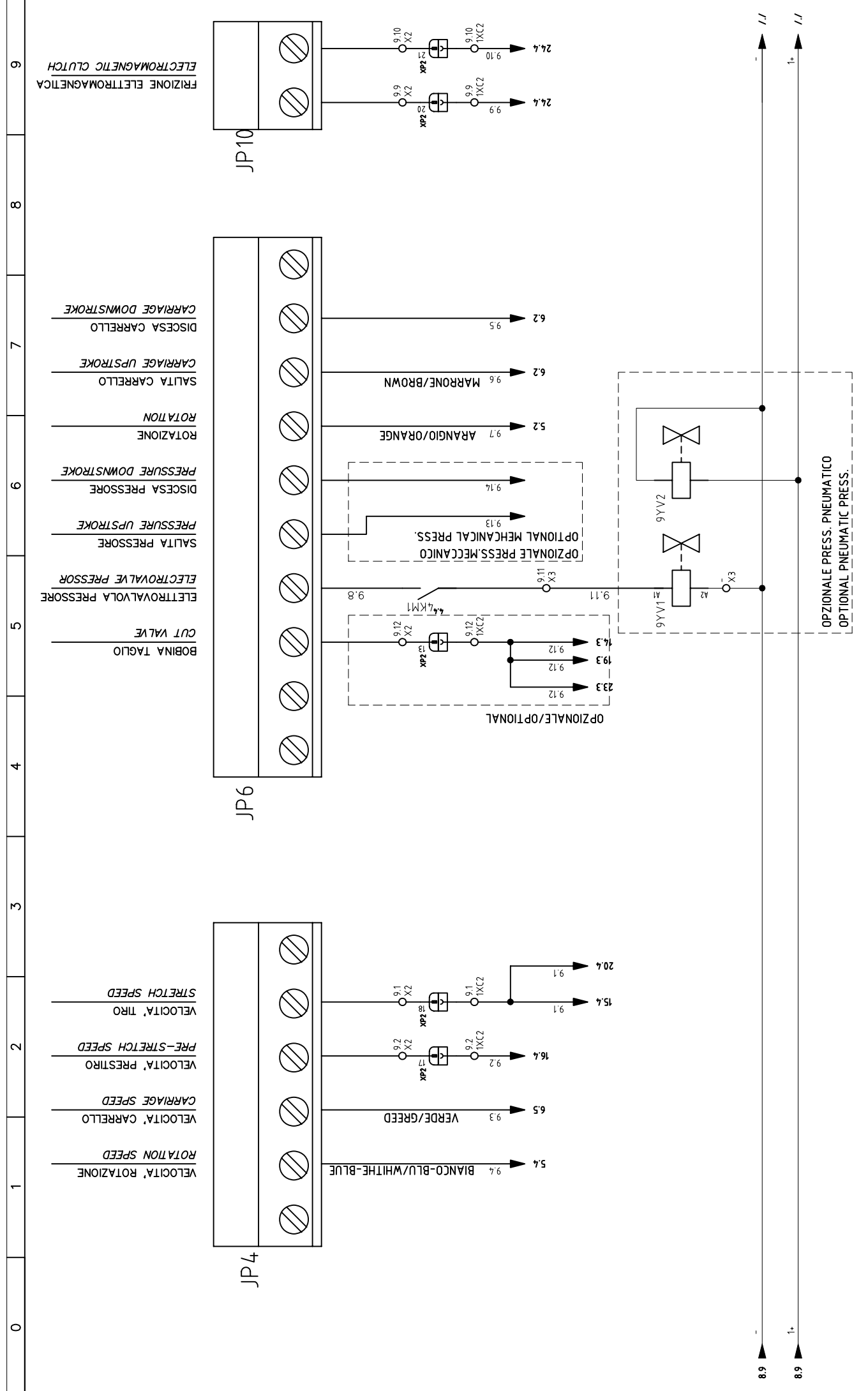

FROMM

Dis. N.	LY00R00P00		
CAD	SPAC		
Nome File	LY00R00P00		
Data	08/12/2012		
Impianto	AWVOLGITORE A BRACCIO FS5xx WRAPPER MACHINE FS5xx		
Denominazione	USCITE DIGITALI DIGITAL OUTPUT		
Ordine			
	Commissa	STD	
	Esecutore	SERVISI A.	
FOGLIO	9		
SEGUE	10		

=QG - X0

Morsettiera Potenza
Power terminal

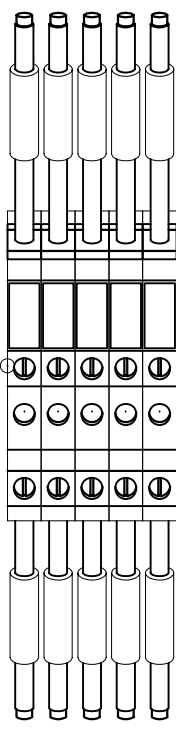

=QG - X3

Morsettiera parte fissa alta
Terminal part fixed high

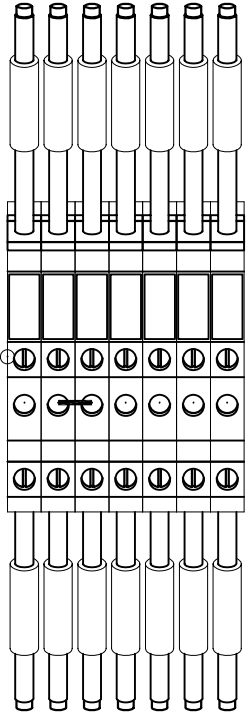

=QG - X2

Morsettiera distributore elettrico
Terminal electrical distributor

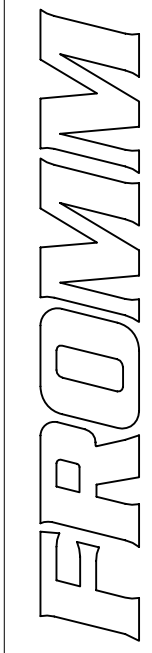
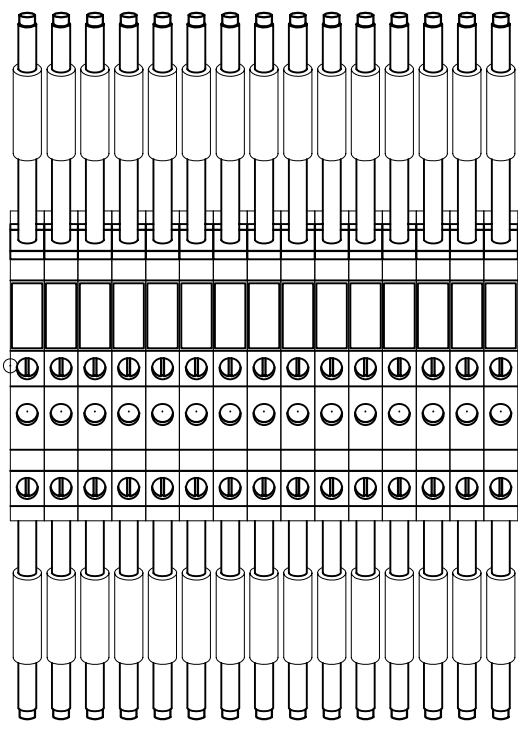

Dis. N.	LY00R00P00	Impianto	AWVOLGITORE A BRACCIO FS5xx WRAPPER MACHINE FS5xx	Ordine		FOGLIO	10
CAD	SPAC	Denominazione	CONNETTORE QUADRO CABINET TERMINALS	Commessa	STD	SEGUE	
Nome File	LY00R00P00	Data	08/12/2012	Esecutore	SERVISI A.		10A

VISTA SCHEDA A PALO

		JP12						JP4					
		1	2	3	4	5	6	7	8	9	10	11	12
- Aliment. Scheda	L	1	2	3	4	5	6	7	8	9	10	11	12
Fc.Pressore Alto	7.5	L	8.1	9.1	9.2	9.3	9.4	9.5	9.6	9.7	9.8	9.9	10
Sens.Pres.basso	7.6												
- Aliment. Scheda	L												
+ Aliment. Input	L												
Sens. Tavola Fase	7.1												
Ftc. Alt. Pallet	7.2												
Fc. Carrello Basso	7.3												
Fc. Carrello Alto	7.4												
- Aliment. Scheda	L												
Filo Terra	GND												
+ Abilit. Scheda	0 +												
+ Aliment. Input	1 +												
Ftc. Sicur. Transp.	8.3												
Fc. Antischiac.	8.4												
- Aliment. Scheda	L												
+ Aliment. Input	L												
Puls. Start Ciclo	8.6												
Puls. Stop Ciclo	8.7												
Encod. Sal./Disc.	8.8												
Sens. Pesat. Film	8.9												
- Aliment. Scheda	L												
Ponte													
Ponte													
+ Aliment. Scheda	+ 24												
Ponte													
Ponte													
- Aliment. Scheda	-												



Dis. N. LY00R00P00 CAD SPAC	Impianto AWVOLGITORE A BRACCIO FS5xx WRAPPER MACHINE FS5xx	Ordine Commessa STD	Foglio 10A
Nome File LY00R00P00 Data 08/12/2012	Denominazione VISTA SCHEDA	Esecutore SERVIZI A.	SEQUE 11

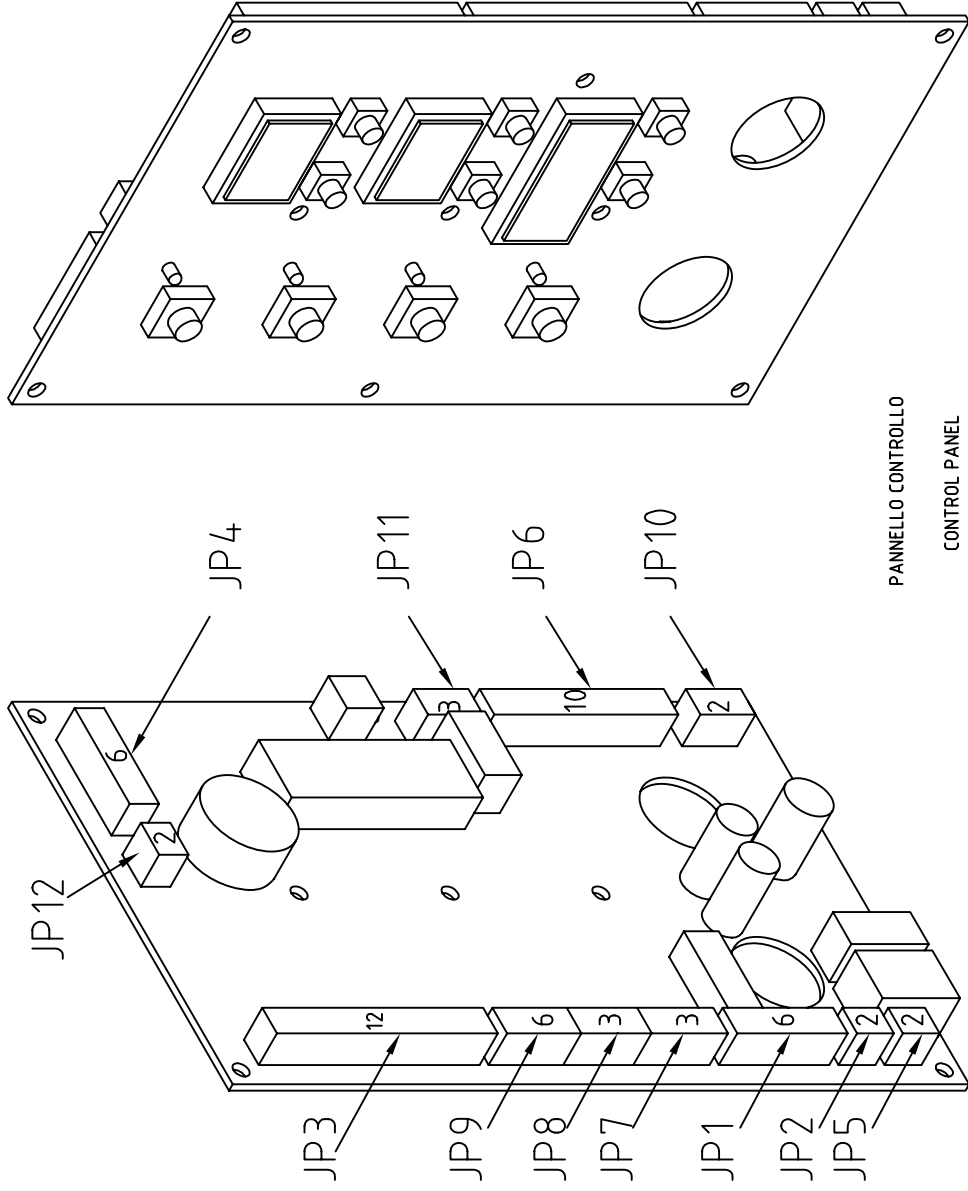

PANNELLO CONTROLLO
CONTROL PANEL

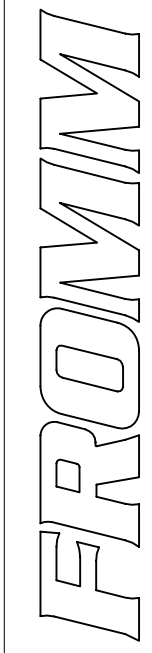

Dis. N.	LY00R00P00	Impianto	AWVOLGITORE A BRACCIO FS5xx WRAPPER MACHINE FS5xx	Ordine		Foglio	11
CAD	SPAC	Denominazione	PANNELLO DI CONTROLLO CONTROL PANEL	Commessa	STD	SEGUE	12
Nome File	LY00R00P00	Data	08/12/2012	Esecutore	SERVISI A.		

0	1	2	3	4	5	6	7	8	9
=BM - XC3									
SCATOLA PARTE FISSA ALTA									
=BM - XP2									
DISTRIBUTORE ROTANTE									
=BM - 1XC2									
cobbettore carrello prestiro									

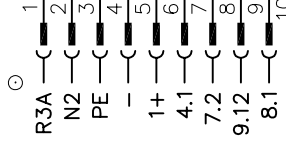
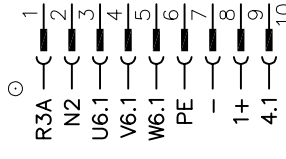
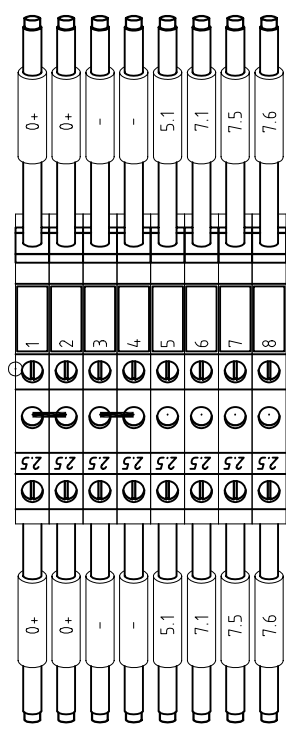

=BM - 2XC2

scatola su braccio

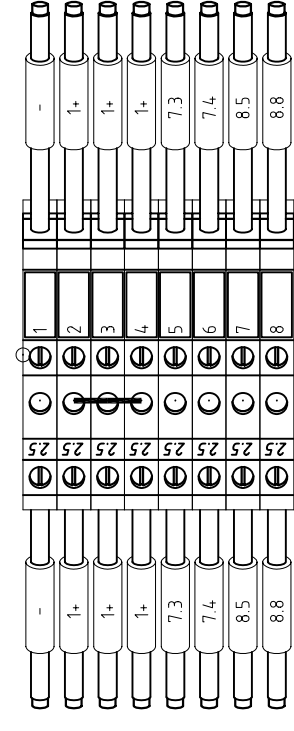

- 220VAC INVERTER
- 220VAC INVERTER
- MOTORE CARRELLO
- MOTORE CARRELLO
- MOTORE CARRELLO
- TERRA
- 24
- +24
- FINE CORSA SPORTELLO
- FTC ALTEZZA PALLET
- MICRO CARRELLO BASSO
- MICRO CARRELLO ALTO
- TAGLIO FILM
- MICRO BANDELLA
- SENSORE BALLERINO
- ENCODER SALITA/DISCESA
- VELOCITA' TIRO FILM
- VELOCITA' PRESTIRO FILM
- SENSORE PESO FILM
- FRIZIONE
- FRIZIONE

- 220VAC INVERTER
- 220VAC INVERTER
- TERRA
- FINE CORSA SPORTELLO
- FTC ALTEZZA PALLET
- TAGLIO FILM
- SENSORE BALLERINO
- VELOCITA' TIRO FILM
- VELOCITA' PRESTIRO FILM
- SENSORE PESO FILM
- FRIZIONE
- FRIZIONE

		Dis. N. LY00R00P00	Impianto	Ordine	Foglio
		CAD SPAC	AWVOLGITORE A BRACCIO FS5xx WRAPPER MACHINE FS5xx	Commissa STD	12
Nome File LY00R00P00	Denominazione	Esecutore		SEQUE	13
Data 08/12/2012	MORSETTIERA BORDO MACCHINA TERMINAL ON BOARD	SERVISI A.			

CARPELLINO

C7

FROMM

Dis. N.	LY00R00P00	Impianto	AWVOLGITORE A BRACCIO FS5xx WRAPPER MACHINE FS5xx	Ordine	Foglio
CAD	SPAC				
Nome File	LY00R00P00	Denominazione	COPERTINA C7 C7 COVER	Esecutore	SEGUE
Data	08/12/2012				

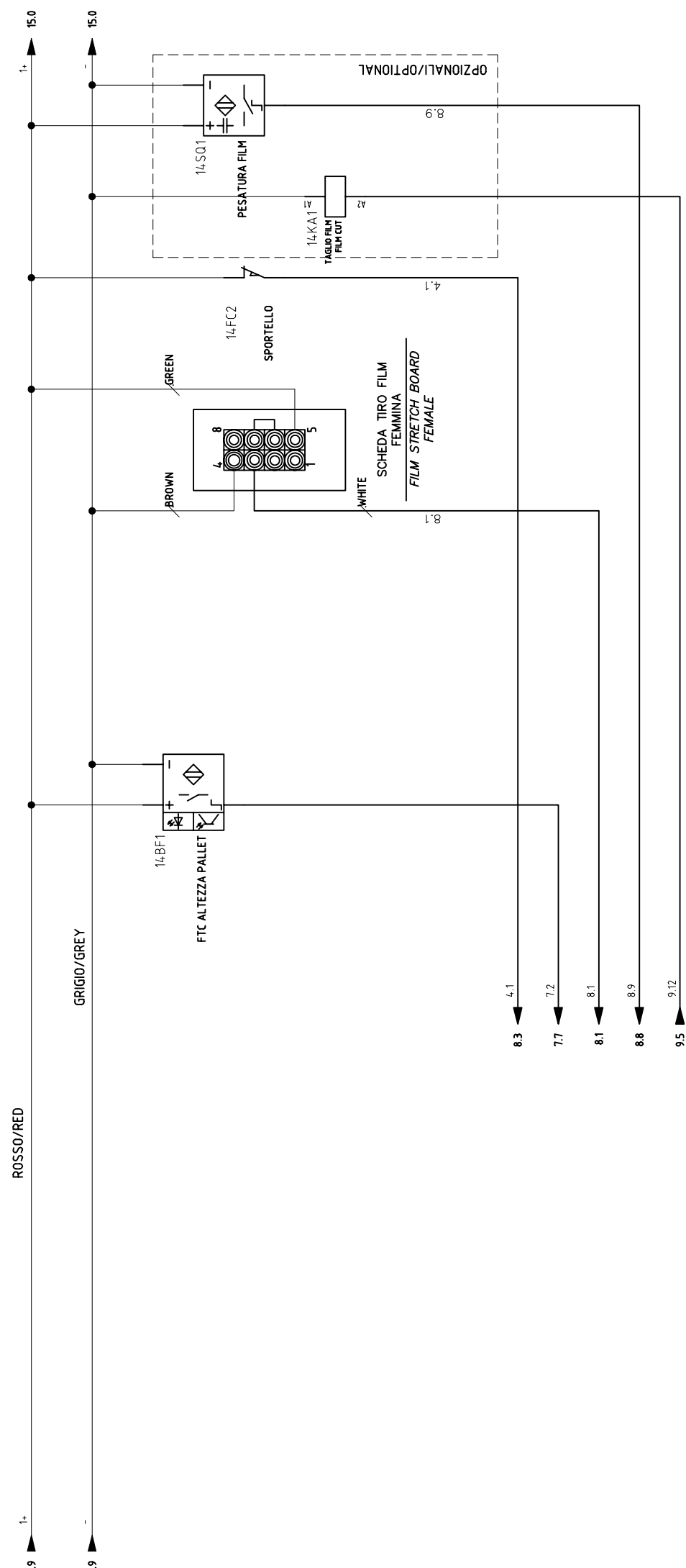

<h1 style="font-size: 4em; margin: 0;">FAROMM</h1>	Dis. N. LY00R00P00		Impianto		Ordine		FOGLIO	
	CAD SPAC		AWVOLGITORE A BRACCIO FS5xx WRAPPER MACHINE FS5xx		Commissa STD		14	
	Nome File LY00R00P00		Denominazione CONNETTORE AUSILIARI CARRELLO CARRIAGE AUX CONNECTOR		Esecutore SERVISI A.		SEQUE	
	Data 08/12/2012						15	

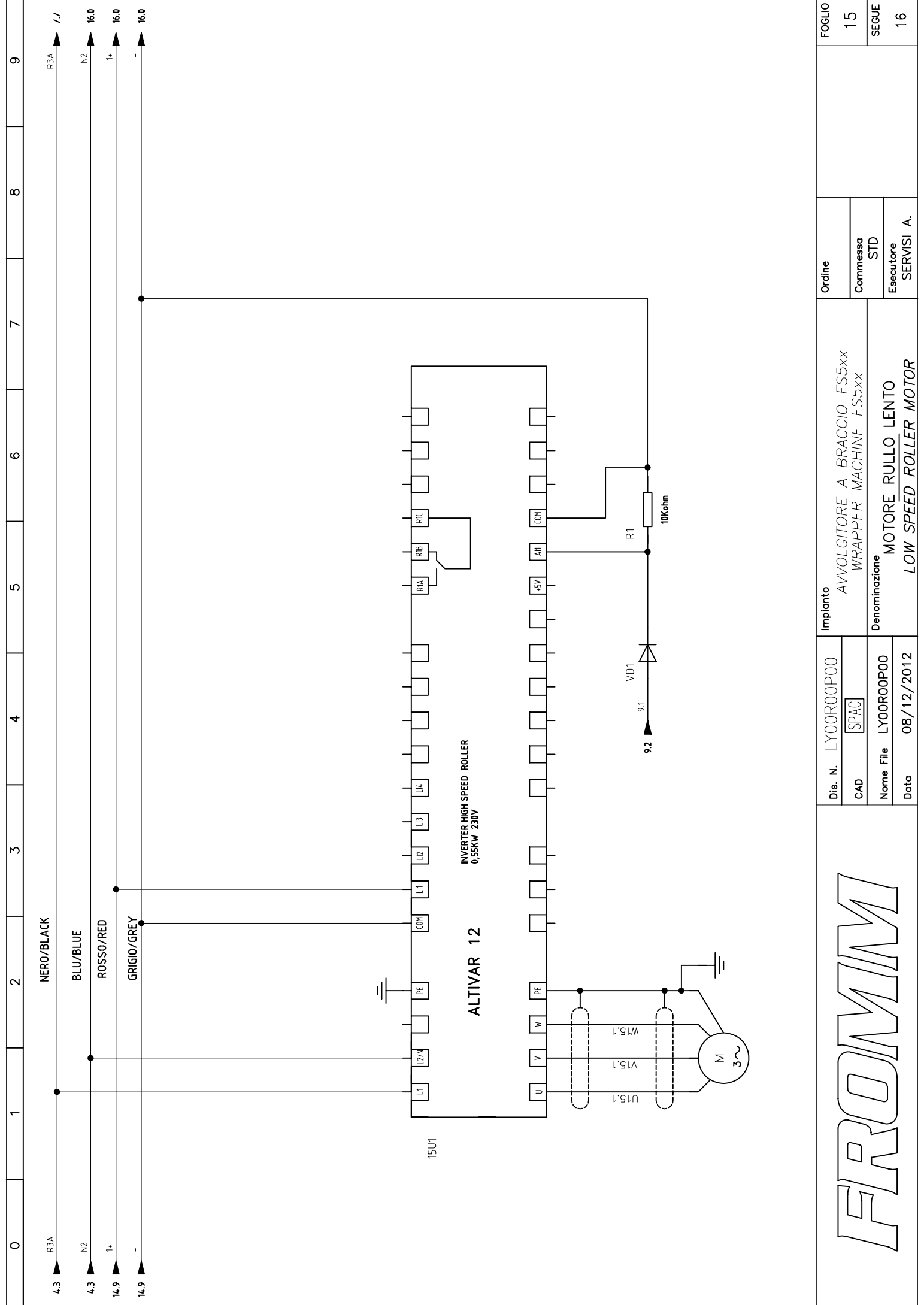

0	1	2	3	4	5	6	7	8	9
---	---	---	---	---	---	---	---	---	---

4.3	R3A	NERO/BLACK	16.0	/ /
4.3	N2	BLU/BLUE	16.0	N2
14.9	1+	ROSSO/RED	16.0	1+
14.9	-	GRIGIO/GREY	16.0	-

Dis. N.	LY00R00P00	Impianto	AWVOLGITORE A BRACCIO FS5xx WRAPPER MACHINE FS5xx	Ordine		FOLGIO	15
CAD	SPAC	Denominazione	MOTORE RULLO LENTO LOW SPEED ROLLER MOTOR	Commissa	STD	SEGUE	16
Nome File	LY00R00P00	Data	08/12/2012	Esecutore	SERVISI A.		

FAROMM

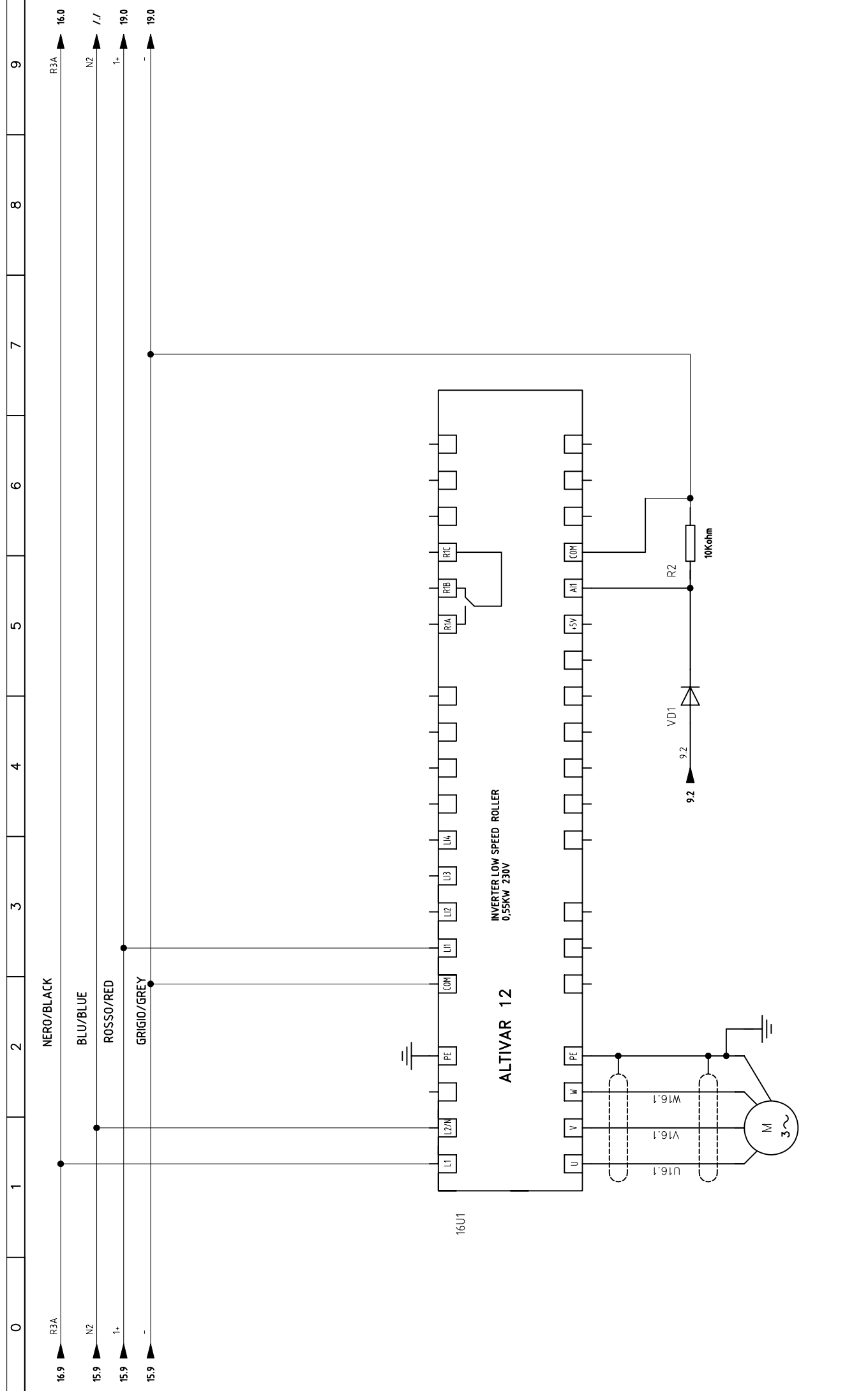

<h1 style="text-align: center;">FROMM</h1>		Dis. N.	LY00R00P00	Impianto	AWVOLGITORE A BRACCIO FS5xx WRAPPER MACHINE FS5xx		Ordine	FOGLIO	
		CAD	SPAC	Denominazione	MOTORE RULLO VELOCE FAST SPEED ROLLER MOTOR		Commessa	STD	16
		Nome File	LY00R00P00	Data	08/12/2012	Esecutore		SERVISI A.	
								SEQUE	
								17	

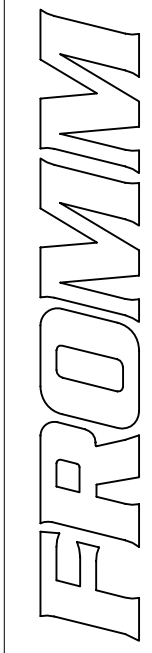

Dis. N. LY00R00P00	Impianto	AWVOLGITORE A BRACCIO FS5xx WRAPPER MACHINE FS5xx	Ordine	Foglio
				17
CAD			Commessa	Esecutore SERVISI A.
			STD	
Nome File LY00R00P00	Denominazione	SCORTA		
Data 08/12/2012		SPARE		18

CARRELLINO

C6

FROMM

Dis. N.	LY00R00P00	Impianto	AWVOLGITORE A BRACCIO FS5xx WRAPPER MACHINE FS5xx	Ordine	Foglio
CAD	SPAC				
Nome File	LY00R00P00	Denominazione	COPERTINA C6 C6 COVER	Esecutore	SEGUE
Data	08/12/2012				

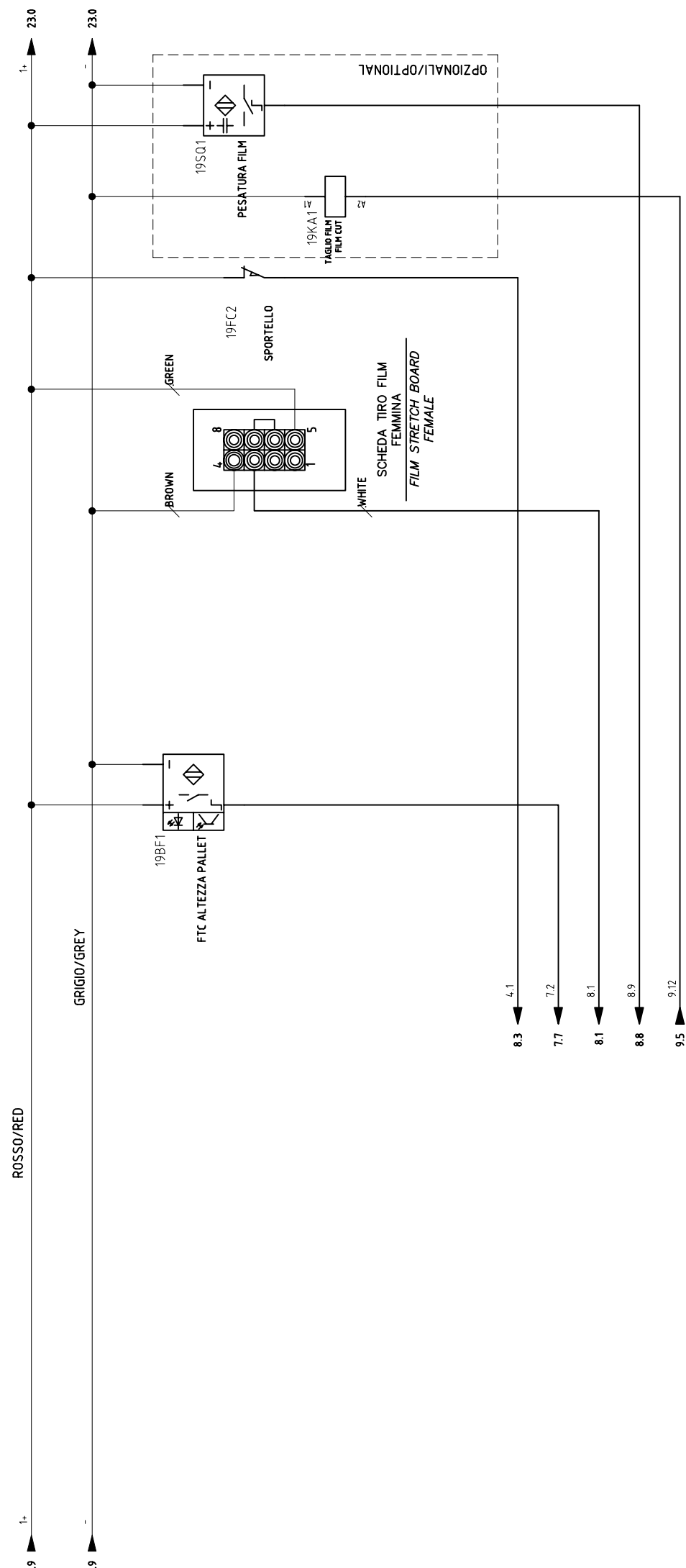

<h1 style="font-size: 4em; margin: 0;">FAROMM</h1>	Dis. N. LY00R00P00	Impianto AWVOLGITORE A BRACCIO FS5xx WRAPPER MACHINE FS5xx		Ordine Commissa STD		FOGLIO 19	
	CAD SPAC						
	Nome File LY00R00P00	Denominazione CONNETTORE AUSILIARI CARRELLO CARRIAGE AUX CONNECTOR					
	Data 08/12/2012						

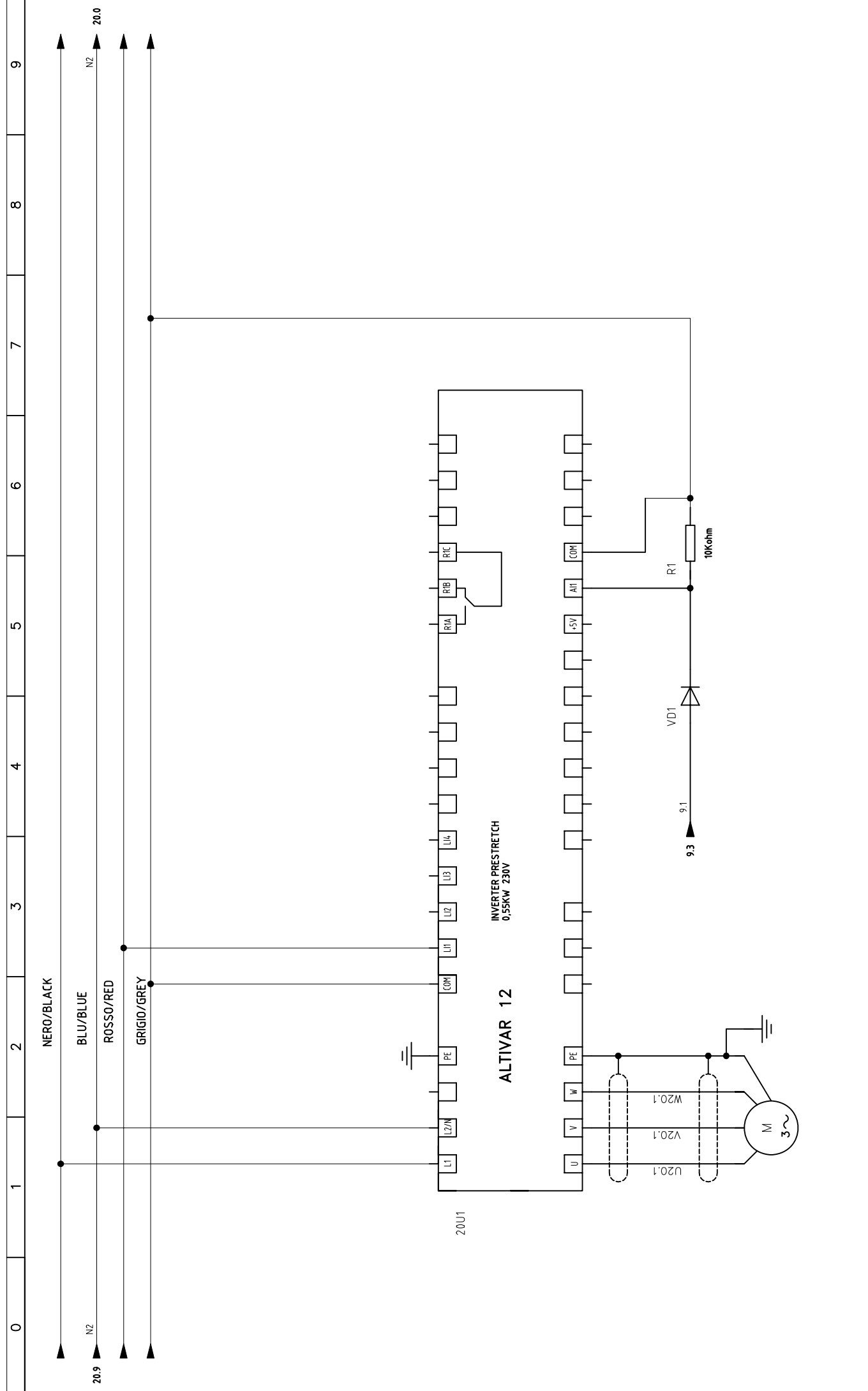

<h1 style="text-align: center;">FROMM</h1>											
Dis. N. LY00R00P00		Impianto		AWVOLGITORE A BRACCIO FS5xx WRAPPER MACHINE FS5xx						Foglio	
CAD SPAC										20	
Nome File LY00R00P00		Denominazione		MOTORE RULLO LENTO LOW SPEED ROLLER MOTOR						SEGUE	
Data 08/12/2012										21	
		Ordine		Commissa STD						Esecutore	
										SERVISI A.	

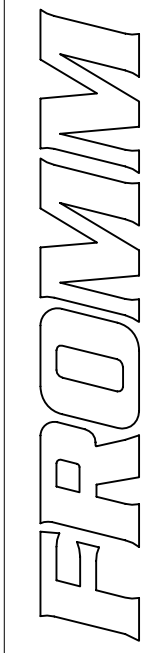

Dis. N.	LY00R00P00	Impianto	AWVOLGITORE A BRACCIO FS5xx WRAPPER MACHINE FS5xx	Ordine	FOLIO
CAD	SPAC				
Nome File	LY00R00P00	Denominazione	SCORTA SPARE	Esecutore	SEGUE
Data	08/12/2012				

C A P R E L L O

C 4 / C 2

<h1 style="margin: 0;">FROMM</h1>	Dis. N. LY00R00P00		Impianto AWVOLGITORE A BRACCIO FS5xx WRAPPER MACHINE FS5xx	Ordine Commessa STD	Foglio 22
	CAD	SPAC			
	Nome File	LY00R00P00			
	Data	08/12/2012			

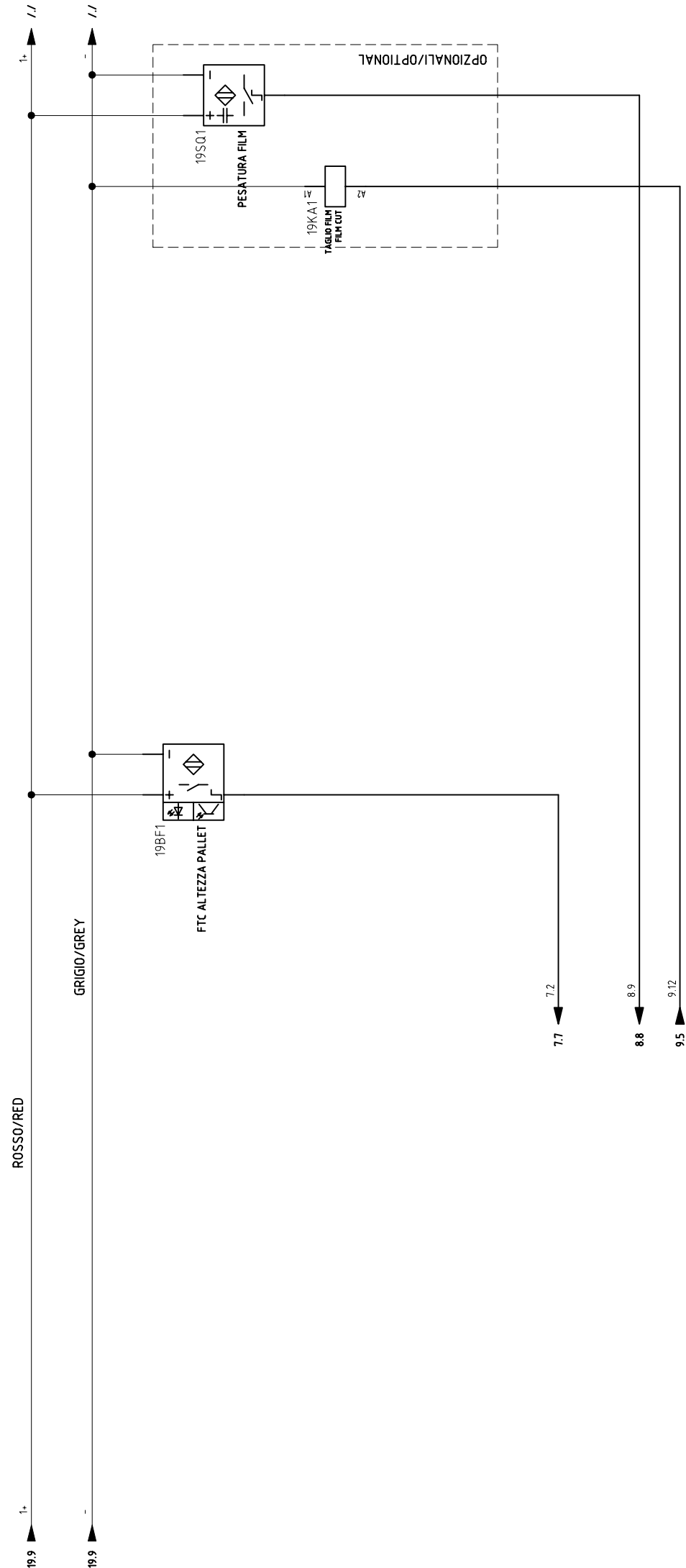

<h1>FAROMM</h1>	Dis. N. LY00R00P00	Impianto	Ordine	Foglio
	CAD SPAC	AWVOLGITORE A BRACCIO FS5xx WRAPPER MACHINE FS5xx	Commissa STD	23
	Nome File LY00R00P00	Denominazione CONNETTORE AUSILIARI CARRELLO CARRIAGE AUX CONNECTOR	Esecutore SERVISI A.	SEGUE
	Data 08/12/2012			24

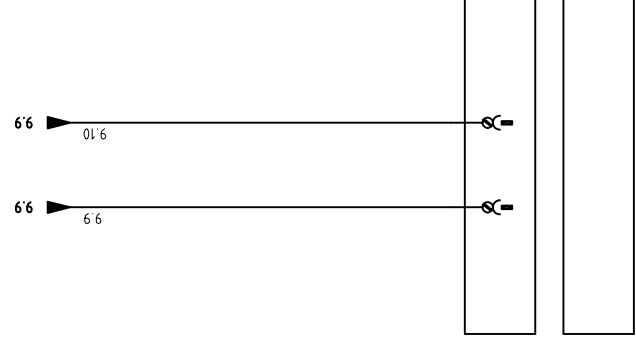

<h1 style="text-align: center;">FROMM</h1>		Dis. N. LY00R00P00		Impianto		Ordine		FOGLIO	
		CAD SPAC		AWVOLGITORE A BRACCIO FS5xx WRAPPER MACHINE FS5xx		Commissa STD		24	
		Nome File LY00R00P00		Denominazione FRIZIONE ELETTROMAGNETICA ELECTROMAGNETIC CLUTCH		Esecutore SERVISI A.		SEGUE	
		Data 08/12/2012						25	

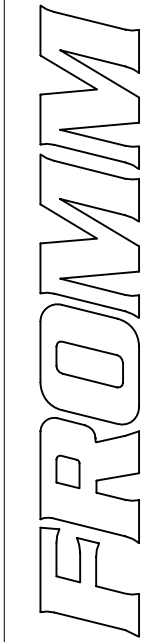

Dis. N. LY00R00P00	Impianto	AWVOLGITORE A BRACCIO FS5xx WRAPPER MACHINE FS5xx	Ordine	FOGLIO	
				25	
CAD			Commissa	SEGUE	
			STD	66	
Nome File LY00R00P00	Denominazione	COPERTINA C2	Esecutore		
Data 08/12/2012		C2 COVER	SERVISI A.		

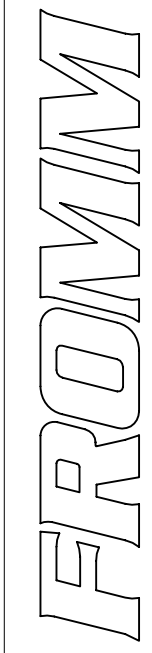

Dis. N.	LY00R00P00	Impianto	AWVOLGITORE A BRACCIO FS5xx WRAPPER MACHINE FS5xx	Ordine	Foglio
CAD	SPAC				
Nome File	LY00R00P00	Denominazione	CONNETTORE AUSILIARI CARRELLO C2 CONNECT AUX	Esecutore	SEGUE
Data	08/12/2012				

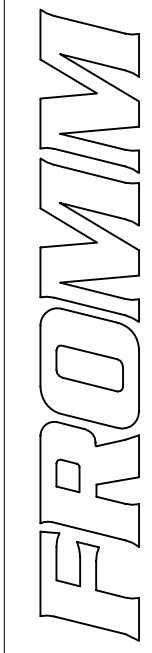

Dis. N.	LY00R00P00	Impianto	AWVOLGITORE A BRACCIO FS5xx WRAPPER MACHINE FS5xx	Ordine	Foglio
CAD	SPAC				
Nome File	LY00R00P00	Denominazione	LISTA MATERIALE MATERIAL LIST	Esecutore	SEGUE
Data	08/12/2012				