

FROMM

SEMI – AUTOMATIC Stretch Wrapping Machine Serie FS 270 / FS 271

FS 270 Items No. 30.1701
30.1705
30.1710
30.1715

FS 271 Items No. 30.1720
30.1725
30.1730
30.1735

INDEX

	<i>Page</i>
1 Machine make - up	4
2 General	5
3 Safety instructions and devices	6 – 8
4 Warnings	9
5 Identification Sticker	10
6 Technical Data	11 – 12
7 Explanation of pictograms	13
8 Main Components	14
9 Handeling & Transport	15 – 16
10 Installation	17 – 18
11 Assembly Sequence	19 – 21
12 Control panel	22 – 23
13 Basic operating Instructions	24 – 27
14 Alarms & Errors	28 - 32
15 Insering the film	33
16 Maintenance Instructions	34 – 36
17 Maintenance sheme & Lubrificants	37
18 Spare parts	
19 Spare parts lists and exploded vieuws	
20 Electrical schematic	
21 CE-Declaration of Conformity	

B Opgelet!

Leest U in elk geval de gebruiksaanwijzing, vooraleer de machine wordt opgesteld, geïnstalleerd en in gebruik genomen wordt. Daardoor zorgt U voor Uw eigen veiligheid en vermijdt U schade aan Uw machine.

D Achtung!

Lesen Sie unbedingt die Gebrauchsanweisung vor Aufstellung-Installation-Inbetriebnahme. Dadurch schützen Sie sich und vermeiden Schäden an Ihrem Apparat.

D OBS!

De bør absolut læse bruganvisningen, inden maskinen opstilles, installeres og tages i brug. Derved beskytter De Dem selv og undgår skader på maskinen.

E Atención!

Resulta imprescindible leer las Instrucciones de manejo antes de proceder al Emplazamiento/ Instalacion/Puesta en servicio del aparato, con objeto de protegerse a si mismo y evitar el deterioro de la máquina debido a un manejo incorrecto.

F Attention!

Lisez impérativement le mode d'emploi avant l'installation/la mise en service. Vous vous protégez ainsi et éviterez des détériorations sur votre appareil.

GB Important!

Read the operating instructions carefully before installation and before using this machine for the first time.

You will avoid the risk of causing harm to yourself or to your machine in this way.

GR Προσοχή!

Πρίν την εγκατάσταση, σύνδεση και αρχική λειτουργία της συσκευής διαβάστε προσεκτικά τις οδηγίες χρήσης.

Έτσι προστατεύετε τον εαυτό σας και αποφεύγετε πιθανές βλάβες συσκευής.

I Attenzione!

Leggere assolutamente le istruzioni d'uso prima di procedere a posizionatura – installazione - messa in funzione. In questo modo ci si protegge e si evitano danni all'apparecchio.

N NB!

De må lese bruksanvisningen før oppstilling, installasjon og start av maskinen! Gjør det for å unngå skade på Dem selv og maskinen.

NL Let op!

Lees beslist de gebruiksaanwijzing voor het plaatsen, installeren en in gebruik nemen van uw machine. Dat is veiliger voor Uzelf en U voorkomt onnodige schade aan Uw machine.

P Atencão!

Leia as instruções de utilização antes da montagem - instalação e - primeira utilização. Assim evita avarias no aparelho.

S OBS!

Läs bruksanvisningen noga före uppställning, installation och användning. Ni förebygger därmed olycksrisker och undviker skador på maskinen.

FIN Huomio!

Tutustukaa huolellisesti käyttöohjeeseen ennen laitteen asennusta ja käyttöönottoa. Näin välttytte mahdollisilta vahingoilta käyttäessä koneetta.

Machine make - up

Serial number :

Delevery Date :

Art.-Nr.	Model		
30.1701	FS270	FS270/1650/2500/2000/230V/50HZ	<input type="checkbox"/>
30.1705	FS270	FS270/1800/2500/2000/230V/50HZ	<input type="checkbox"/>
30.1710	FS270	FS270/2200/2500/2000/230V/50HZ	<input type="checkbox"/>
30.1715	FS270	FS270/1650/2500/1200/230V/50HZ	<input type="checkbox"/>
30.1720	FS271	FS271/1650/2800/2000/230V/50HZ	<input type="checkbox"/>
30.1725	FS271	FS271/1800/2800/2000/230V/50HZ	<input type="checkbox"/>
30.1730	FS271	FS271/2200/2800/2000/230V/50HZ	<input type="checkbox"/>
30.1735	FS271	FS271/1650/2800/1200/230V/50HZ	<input type="checkbox"/>

Options

16.8212	FS12	Ramp turntable 1650 mm length 1550 mm Height 71,5 mm	<input type="checkbox"/>
16.8214	FS14	Ramp turntable 1800 mm length 1550 mm Height 71,5 mm	<input type="checkbox"/>
16.8216	FS16	Ramp turntable 1650 mm length 2300 mm Height 71,5 mm	<input type="checkbox"/>
16.8218	FS18	Ramp turntable 1800 mm length 2300 mm Height 71,5 mm	<input type="checkbox"/>
16.8226	FS26	Pit option, Frame to put the machine into the ground Ø 1650 mm	<input type="checkbox"/>
16.8227	FS27	Pit option, Frame to put the machine into the ground Ø 1800 mm	<input type="checkbox"/>
16.8242	FS42	Modificationkit FS 270	<input type="checkbox"/>
16.8246	FS46	Automatic filmcutting device	<input type="checkbox"/>

GENERAL

- This manual is only intended for a semi-automatic pallet stretch wrapping machine, FS 270 turntable series with mechanical pré stretch 150% and automatic load height detection, as delivered by FROMM Stretch Wrapping Division.
FS 270 Pallet height 2500 mm
FS 271 Pallet height 2800 mm
- FOR EVERYTHING IN THIS MANUAL IS VALID, IF APPLIED!
- This so-called turntable machine can be build into the floor.
A support frame for building the machine in the floor can be supplied as an option.
- Pre- stretching (Stretching out) the film prior to application on the goods reduces the costs of packaging and is easier on the environment. (Max 150% depending on quality stretchfilm)
Option gearings max 200% depending on quality stretchfilm
- Refer to chapter 6 (Technical data), which describes the installation in detail and for the complete size of the installation.
- Information specific given to FS 271 is normally given in brackets ().
- Read carefully at least the chapters 9 and 10 relating to handling and installation of this wrapping machine.
- For safety reasons the entire instruction manual should be read before setting in operation the machine/installation, solving failures and executing maintenance.
- We particularly draw your attention to the chapters 3 (Safety Instructions) and 4 (Warnings) which point out the intended use and unsafe situations that could not be prevented in the design and manufacture of the wrapping machine.
- The duration of guarantee is provided the following are observed: the uses for which the machine was designed, built and protected, in addition to recommendations, information - including matters of general knowledge - details plus the safety and health technical limits notified to by the Manufacturer to the User by virtue of the Operating, Use.

The same holds true if non-original spare parts are utilized.
- For all the aforementioned reasons, we recommend that our customers always notify the Service Department.

SERVICE DEPARTMENT

Please contact, in case of problems:

SPARE PARTS

Spare parts can be ordered from:

SAFETY INSTRUCTIONS**ATTENTION!**

The following conditions have always to be satisfied, unless otherwise indicated in other instructions in this manual.



- This wrapping machine has been delivered by FROMM Stretch Wrapping Division and may only be applied for wrapping of pallets which meet the requirements as mentioned in the description of the machine in chapter 6 (Technical data).
Any other use of the machine as for the described purpose may cause danger due to damage to the machine and/or the safety of the operator or other persons in the neighbourhood of the machine.
- Read this manual carefully before using the machine
- The machine is not fit with components that involve special decommissioning problems.
- Only personnel trained for the purpose may operate the machine
- Use the emergency stop to halt the machine immediately
- Only trained electricians may perform electrical work on the machine
- When installing the machine, as a precaution, always check that the controls and safety systems are correctly mounted and operating efficiently. If any malfunctions are noted, immediately stop the production cycle and ask the authorised technical service to intervene
- Examine the data-plates. If they are in poor condition, replace them with utmost urgency, strictly and directly contacting the authorised technical service or the Manufacturer
- The requirements, as mentioned in chapter 16 (Maintenance Instructions) should be satisfied during adjustment and maintenance activities
- People should not step on to means of transport, unless indicated clearly otherwise
- People should not find themselves above the means of transport
- Do not place tools and components on the machine
- Safety devices should not be bridged and put out of operation
- The manufacturer will only make the machine ready for operation, when the electrical main connection satisfies the standards applicable in the country of delivery
- The supplier will do the training of the operating personnel. If not, the training will have to be done properly by the company that takes care of the installation

- The machines are designed and implemented conforming to the safety laws in force. Consequently, no intrinsic fire risks are envisaged when the machine is used normally
- As such, the equipment provided against the possibility of **fire outbreaks** inside the company are sufficient for any problems caused by the material used for the process
- In the event a fire breaks out and fire extinguishers are used, it is recommended that extinguishers filled only with CO2 be used, so as not to damage both the equipment on the machine and the wiring system
- In the event of **flooding**, it is compulsory that all the power supplies be disconnected before entering the room in which the machine is installed
- In the event the wrapping machine was subjected to a flooding, contact the Customer technical service of MANUFACTURER

SAFETY DEVICES

We urge on you again that all safety devices are installed for the safety of the operator etc. and should not be bridged and put out of operation.

Refer to the drawing below for the applied references.

Survey control panel

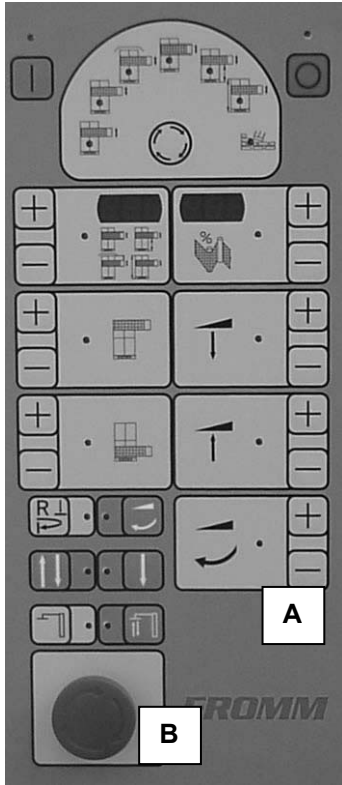

A = Acoustic signal
B = Emergency stop

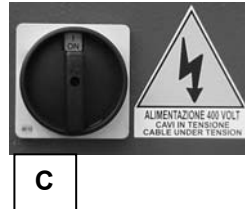

C = Lockable main switch

The main supply (1x230V) is switched on and off with the main switch. The supply voltage for the control part (24VAC) is thus equally switched on and off.



D = crush-proof guard

This is a mobile crush-proof guard, interlocked by means of a microswitch. Any time underlying foreign matter comes into contact with the guard, it inverts the film carriage's motion for approximately 3 seconds and causes the turnplate to stop in phase

WARNINGS

- The mean weighed noise level of the machine is less than 80 dBa. It is possible that, depending on the applied film, during wrapping of the pallets incidentally a noise level with a maximum of 80 dBa will be measured. Carrying of noise protecting devices is advised.
- One has to reckon with the possibility that the film (roll) contains an electrostatic charge.
- Utmost caution has to be taken with respect to the complete electrical installation. ONLY trained persons may carry out activities to it, after having taken the required safety measures as mentioned in chapter 3 (Safety Instructions).
- One has to reckon with the European safety requirements and standards if the machine has to be adapted and thus safety measures or protection covers also have to be adapted.
- Touching the electrical equipment will hazard your personal safety.
- Persons who carry out changes in or adaptations (function, operation or principles) to the machine are fully responsible for those changes and/or adaptations.
- All relevant safety measures should be taken when carrying out any activity on the machine, especially during maintenance activities and solving failures.
Take care that the main switch is switched off (position "0") and locked in order to prevent other persons in putting in action the machine during your activities.
All the normally valid safety measures or customs with respect to safety should also be taken during those activities.
- Playing with or around the machine may cause dangerous situations with a machine in operation. This playing is never allowed!
- All other prescriptions and laws with respect to working conditions and safety on the working spot should be observed with this machine.
- An acoustic signal device has been installed in the control cabinet, which will be activated first during 3 seconds as a warning every time before the machine is starting.

EXPLANATION IDENTIFICATION STICKER

An identification sticker with the following information has been mounted at the backside of the control cabinet. As second identification sticker is mounted inside the electrical compartment.



Name of the manufacturer	: FROMM Stretchwrapping Division.
Type	: Machine type.
Serialnr.	: Production number of manufacturer.
Voltage	: Supply voltage.
Power	: Used power
Fuse	: 16 Amp
Year of manufacture	: Year in which the machine has been built by manufacturer.

Besides, the CE-mark has been placed on the identification plate:

CE-mark : machine fulfils the applied requirements as mentioned in the CE-machine directives
 98/37/EEC Machines
 89/336/EEC
 92/31/EEC Electro magnetic compatibility
 73/23/EEC
 93/68/EEC Low voltage

- It is strictly prohibited to remove the identification sticker or to replace it with any other similar one of any type.
- Should the CE mark sticker be damaged for any reason, please notify the MANUFACTURER immediately.

Chapter 21 : CE-Declaration of Conformity

TECHNICAL DATA

Machine	<ul style="list-style-type: none"> - Maximum speed turntable - Capacity - Operational hours - Sealing height FS 270 - Sealing height FS 271 	<ul style="list-style-type: none"> 15 r.p.m. max. 20 pallets/hr. 8 hrs/day, 5 days/week minimum of 3090 mm / 122" minimum of 3590 mm / 142" 	
Weight	<ul style="list-style-type: none"> - Total weight FS 270 - Total weight FS 271 - Total weight FS 272 - Total weight FS 273 	<ul style="list-style-type: none"> Ø 1650 mm Ø 1800 mm Ø 2200 mm Ø 1650 mm Ø 1800 mm Ø 2200 mm Ø 1650 mm Ø 1800 mm Ø 2200 mm Ø 1650 mm Ø 1800 mm Ø 2200 mm 	<ul style="list-style-type: none"> approx. 450 kg approx. 480 kg approx. 560 kg approx. 465 kg approx. 495 kg approx. 575 kg approx. 480 kg approx. 510 kg approx. 590 kg approx. 495 kg approx. 525 kg approx. 590 kg
Conditions	<ul style="list-style-type: none"> - Environmental temperature - Environment 	<ul style="list-style-type: none"> + 5 to +30°C clean, dry and non-aggressive 	
Electrical	<ul style="list-style-type: none"> - Power supply - Control voltage - Motor turntable - Motor film carriage - Motor Pre Stretch - Installed power - Protection class 	<ul style="list-style-type: none"> 1 x 230 V 50/60 Hz 24 VAC 0.55 kW 0.22 kW 0.22 kW 1 kW IP 54 	
Pallet goods	<ul style="list-style-type: none"> - Pallet dimensions (Length x width) - Height with load FS 270 SERIESSERIES(pallet included) 	<ul style="list-style-type: none"> 1550 x 1550 x 140 61" x 61" x 5,5" min. 500 mm / max. 3200 	
mm	<ul style="list-style-type: none"> - Dimensions of load outside pallet - Top of load - Maximal weight 	<ul style="list-style-type: none"> min. 19,7" / max. 126" max. 20 mm / 0,8" per side flat 2000 kg 	
Stretchfilm	<ul style="list-style-type: none"> - LLDPE Material - Spool core diameter - Outer diameter of spool - Film width 	<ul style="list-style-type: none"> Max 35 µ / 0,000138" 76 mm / 3" Max. 260 mm / 11,20" Max. 500 mm / 19,70" 	
Colours	<ul style="list-style-type: none"> - Bottom unit, mast - Turntable disk, cover film carriage - Chassis film carriage - Safety plate under film carriage - Control cabinet 	<ul style="list-style-type: none"> : Blue, RAL 5010 : Yellow, RAL 1021 : Blue, RAL 5010 : Yellow, RAL 1021 : Yellow, RAL 1021 	

- Should the need arise to work with products having a different nature than the above mentioned ones, it is essential that you contact the technical service of **MANUFACTURER** in order to receive written authorization.

DIMENSIONS FS 270 (FS 271 = Height + 500mm / 20")

Refer to the LAYOUT on this page for the dimensions.

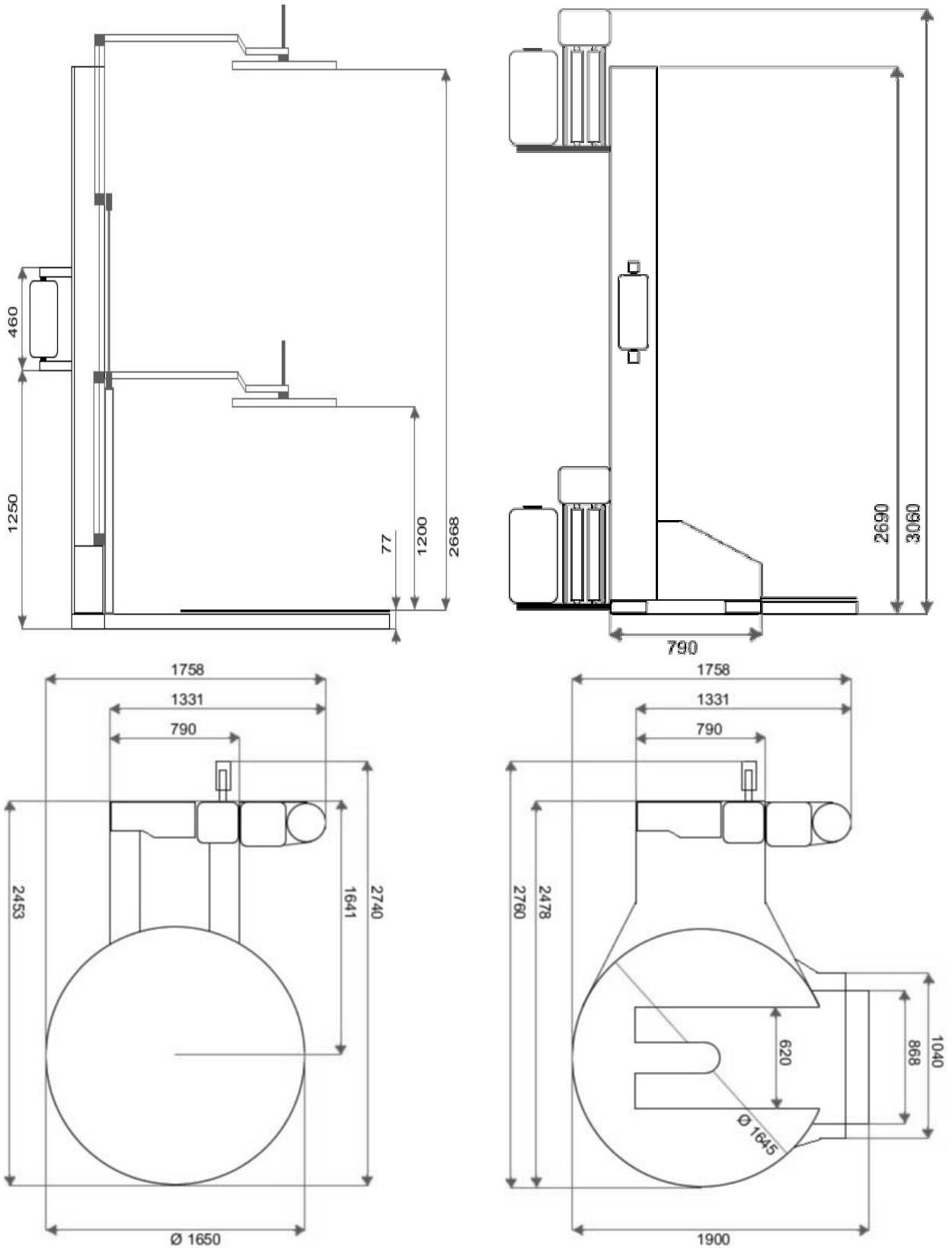

EXPLANATION OF PICTOGRAMS

ATTENTION!!

FOR EVERYTHING IS VALID, IF APPLIED!

WARNINGS



Figure 1

Figure 1:

DANGER
High voltage present.



Figure 2

Figure 2:

Danger Sign



Figure 3

Figure 3:

Risk of crushing one's hands

COMMAND PLATES



Figure 7

Figure 7:

It is prohibited to pass by within the lifting equipment's ray of action

CE-MARK



Figure 8

as mentioned in the CE-machine directives.

MAIN COMPONENTS

The installation as delivered, consists of the following parts:

- 1- Mast
- 2- Control cabinet with control panel
- 3- Film carriage
- 4- Turntable

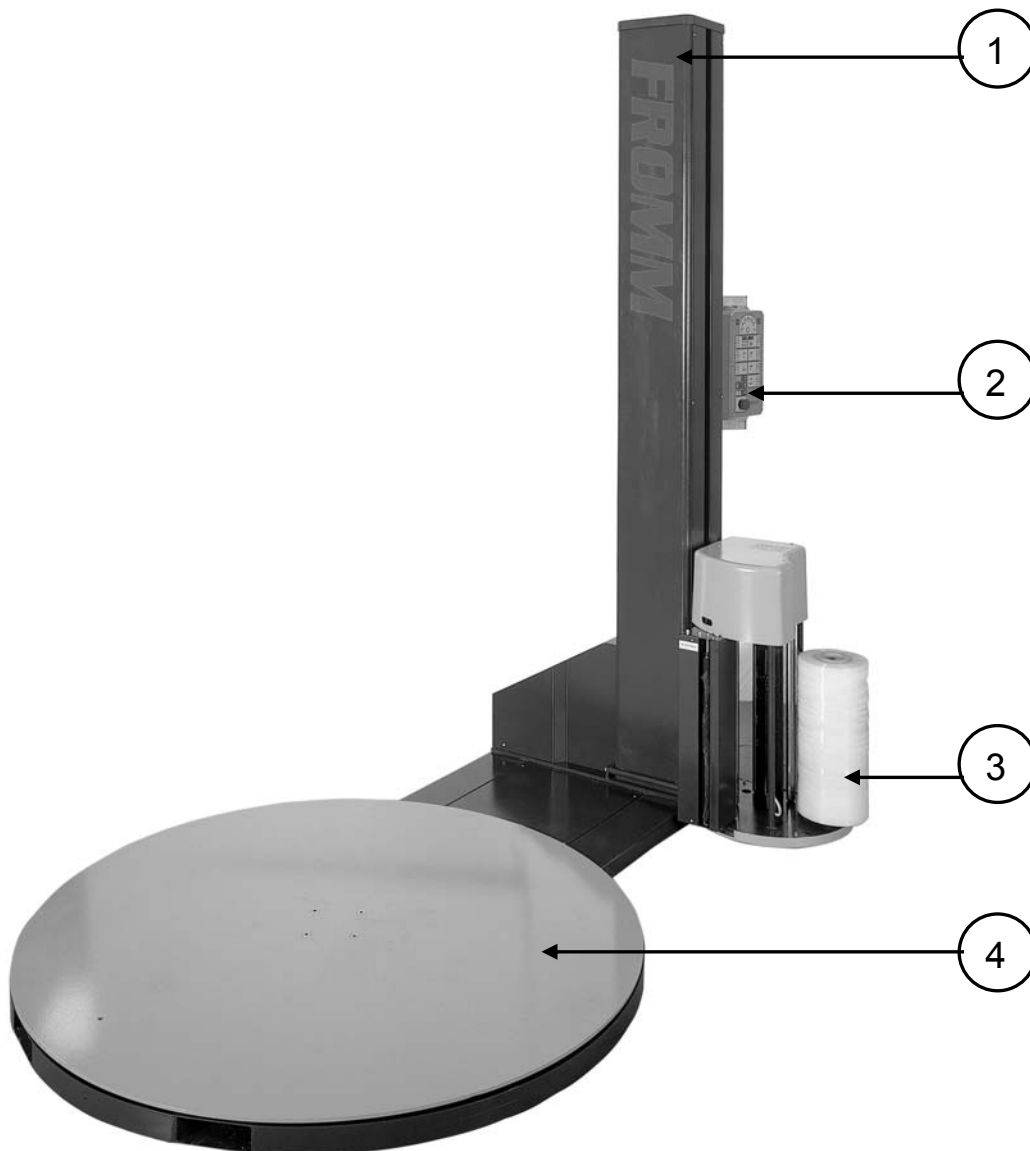

HANDLING & TRANSPORT

ATTENTION !

All mentioned activities may only be executed under supervision of qualified personnel from the manufacturer or his representatives!

Pay attention that proper hoisting and lifting tools are used for handling of the machine.

The machine is supplied in a wooden crate insulated by plastic air bubble film. It is advisable that two another operators be in attendance on the ground when the machine is moved by means of the mechanical equipment driven by the operator in charge since the size of the machine may prevent a clear view during the various phases of the handling operations.

Depending on weight, dimensions, location of machine on the vehicle, available installation space lifting methods and points suitable for the operations described below must be used, fully observing the current safety and health laws and the Manufacturer's recommendations.

Lifting and handling of packing in a wooden crate by crane

- use a crane and sling of sufficient strength
 - bring the vehicle near to the lifting pallet
 - pass the sling (and/or ropes - chains) around the case in the positions indicated by the external markings (1);
- First check that the case - sling/hook (2) are well secured, then carefully lift the case and place it in the designated area, moving it gently.

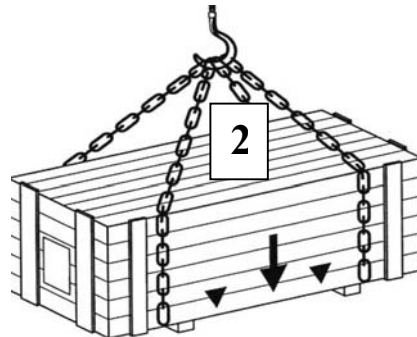
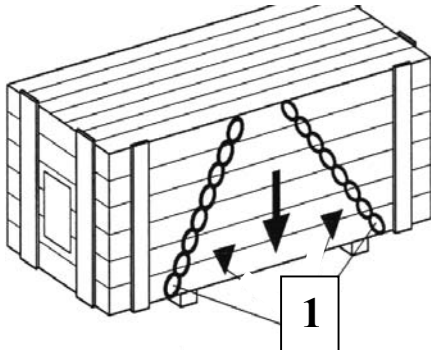

Lifting and handling of packing in a wooden crate by fork-lift truck

Lifting and transport must be effected by a fork-lift truck suitable to bear the weight of the machine, its accessories and packing.

Always check in advance that sufficient space is available for the operations.

- slide the forks (1) of the truck under the casels support base, in line with the indicator-marks printed (2).
- lift the load after ensuring it is stable, and transport it to the area in which packing is to be removed, avoiding jerks and dangerous cambers.

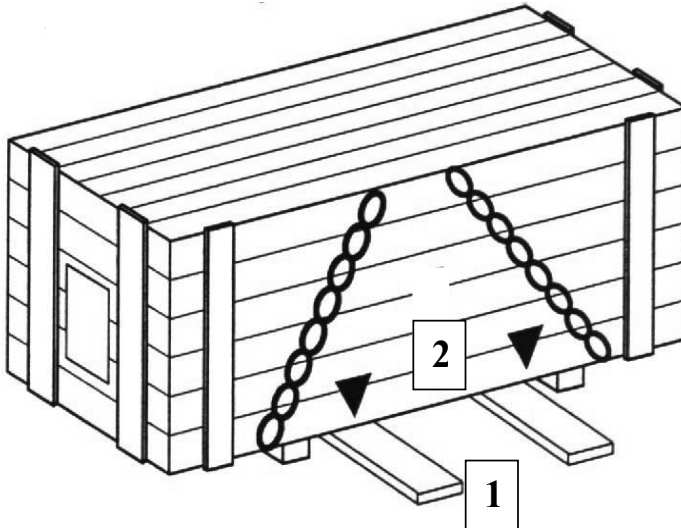

Following measures have to be taken for transport and storage of the machine:

- One has to take care for a suitable storage environment respectively packaging during long-term storage.

Drag bands etc., if used, in order to attach several parts may never be tightened over vulnerable parts, such as control panel, ventilation grills, etc.).

Handling the unpacked machine

Should any machine components be shipped together with the machine, handle them adopting all safety precautions



insert the forks of the suitable lifting equipment within the specific guides (1)

Machine storage

The machine and any components packed together with it are protected by a plastic covering that does not guarantee long storage times.

The machine must never be stacked nor is it capable of supporting external loads.

INSTALLATION INSTRUCTION

ATTENTION!

All mentioned activities may only be executed under supervision of qualified personnel from the manufacturer or his representatives!

Refer to layout in chapter 3 (Safety devices) for mentioned position numbers.

General guideline

Always check in advance that the minimum conditions for machine placing and operation are observed, in particular: ambient conditions (suitable floor), temperature, humidity, lighting and suitability of the designated area.

Installation in rooms subject to the risks of flooding, explosion and fire is strictly forbidden.

The area necessary for installation of the wrapping machine is the area according to the dimensions on the layout plus enough space for installing and working on the machine.

Installation must be executed by qualified personnel, directly co-ordinated by the authorised Technical Service, fully observing the instructions that follow, in addition to current safety and health laws.

As a precaution, always check for any damage caused during transport and handling work. If necessary, contact the Manufacturer directly.

Temperature

For safety make sure the machine is operating at ambient temperature in the range +10°C to +30°C. If other values are measured, contact the Authorised Technical Service with utmost urgency.

Work areas

It is strictly forbidden to locate and/or use the machine if the ambient conditions are liable to cause risks of explosion or inflammability.

Ensure that the following are not present: dust concentration, gas, dangerous fumes and particles, electrostatic fields, excessive electro-magnetic flow, or anything else that might be harmful to persons so exposed or to the efficient running of the machine.

In any event, observe the current safety and health laws.

The machine should be placed on a flat, rigid, vibration-free concrete floor

Never access the high parts of the machine improperly.

Energy sources

The client must provide a cable suited for the required supply voltage up to the control cabinet, of which the diameter of the conductors can manage the total of the required power as mentioned in chapter 6 (Technical Data).

The wrapping machine should preferably be connected to the customer's supply voltage wall socket with a connecting cable with a standard 230 Volt CEE-plug, being fused with a 16A-fuse (slow). A main switch preceding the plug has to be provided by the customer, if necessary.

The mains supply must satisfy the applicable standards, such as permitted voltage fluctuations, ripple-generation, reduction of high harmonics, etc.

INSTALLATION INSTRUCTION

ATTENTION!

All mentioned activities may only be executed under supervision of qualified personnel from the manufacturer or his representatives!

FOR EVERYTHING IS VALID: IF APPLIED!

Due to shipping requirements, the shaft (1) is usually shipped horizontally and bears on a support that has been specifically set up for it. Consequently the shaft must be re-positioned when the machine is installed.

- upon having located the machine, lift the shaft (1) by turning it around the fulcrum shaft that has been specifically setup and then locate the shaft upright as compared to the turnplate
- secure the shaft vertically to the relative plate with the three screws (3) (Figure 2)
- tighten the two stabilizing screws (4) (Figure 2)
- Place the motor cabinet over the motor and secure with screws (Figure 3)

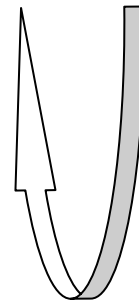

Figure 1

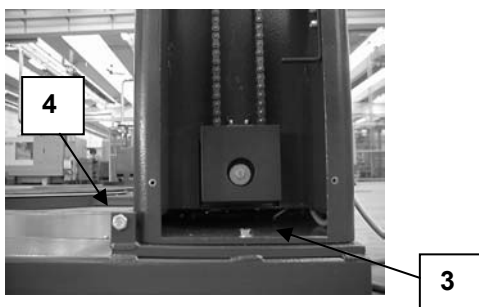

Figure 2

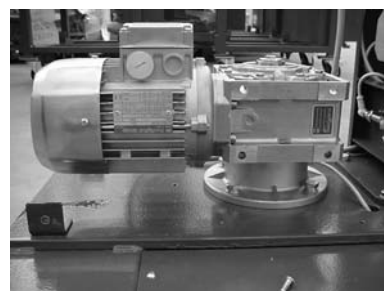

Figure 3

ASSEMBLY SEQUENCE



Figure 4:
Are the limited switches of the filmcarrige working correctly

Figure 4



Figure 5:
Does the filmcarrige work accordingly description?

Figure 5



Figure 6:
Is the fotoelectric cell mounted properly?

Figure 6

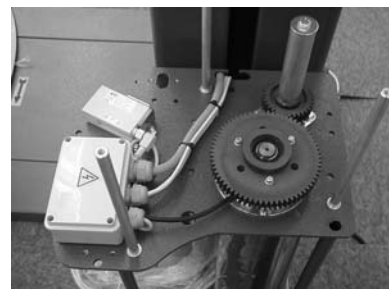

Figure 7:
Does the mechanical pré-stretch work properly?

Figure 7



Figure 8:
Option kit 16.8242 mounted properly?

ASSEMBLY SEQUENCE

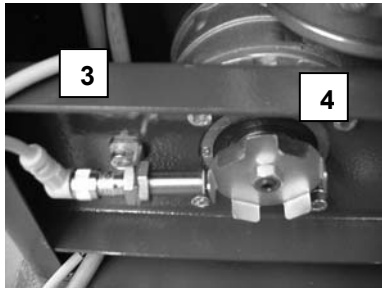

Figure 9

a sensor (3) for checking the speed of the carriage motor: it reads the notches of a phonic wheel (4).



Figure 10

Should the need arise to move the turnplate, fit the two lifting eyebolts in the specific holes drilled on the table for inserting the hooks of the lifting ropes that should be of adequate load bearing capacity

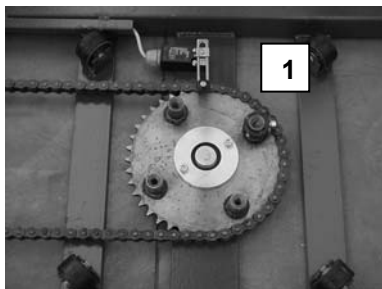
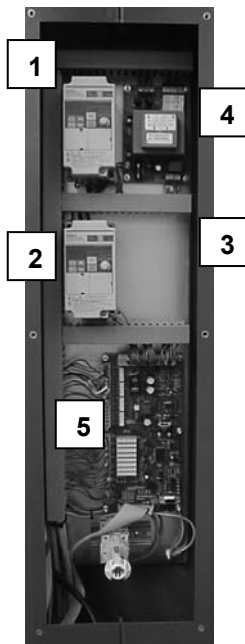

Figure 11

a sensor (1) for checking the speed of the rotation motor: it reads the notches of a phonic wheel divided in four sectors.

ELECTRICAL CABINET



- 1 = Table rotation inverter
- 2 = Carriage inverter
- 3 = Pre-stretching inverter (Kit 62.8242)
- 4 = Feeder
- 5 = Control card

Figure 12

ATTENTION!

After the first installation

Follow procedure below before starting the machine

- Control if the emergency button is free
- Turn on the machine
- Wait 5 seconds and then make the first rotation in manual mode
- If the turntable rotates, follow procedure below

After installation or maintenance of the machine follow procedure below to check the efficiency of the safety devices, such as:

- ✓ **Interlocking of the crush-proof interlocked operator guard**
- ✓ **Emergency button**

Check for the efficiency of the mobile interlocked crush-proof guard of the carriage

- start the machine
- trigger the interlocked operator guard

Check that the carriage inverts its running direction for approximately 3 seconds and that the turnplate starts slowing down and stops within a few seconds

Check for the efficiency of the mushroom-head button (Emergency stop)

- start the machine
- press the emergency mushroom-head button

Check that the machine stops within a few fractions of a second

CONTROL PANEL

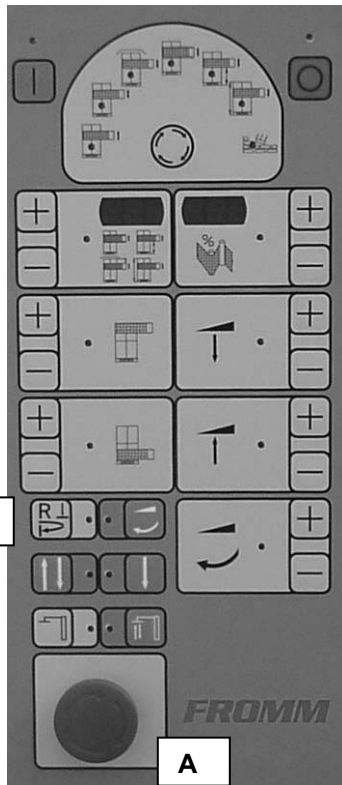

Figure 1: Console FS 270

A = Emergency stop
B = Reset button

Function

- Press «+» or «-» for changing the parameters
- The function setting is stored immediately for all programs. You can insert different settings to different programs.
- You may change all parameters even while the machine is operating.

- AL 1 = Carriage emergency limit switch
- AL 2 = Main contactor
- AL 3 = Inverter overload
- AL 4 = Transpallet sensor
- AL 5 = Film tearing alarm (optional)
- AL 6 = Encoder sensor
- AL 7 = Toppres sensor

ALARM RESET

After having cleared the fault, push the **RESET button**

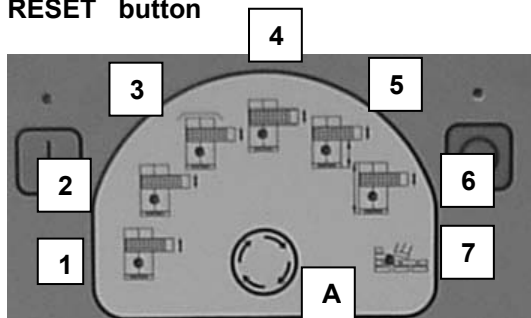

Operating mode selector switch (A):

- 1 – wrapping, ascent or descent only
- 2 - wrapping ascent / descent
- 3 – wrapping, ascent with cover sheet positioner
- 4 – stiffening cycle
- 5 – start from preset height
- 6 – photocell disable
- 7 – implementation of personalized programs

INDICATIONS**START-UP CYCLE ACTIVE**

- An acoustic signal device has been installed in the control cabinet, which will be activated first during some seconds as a warning every time before the AUTOMATIC PROGRAM is executed.
The operator will thus be able to leave the danger zone before the machine starts to operate.
The machine will only start to operate after this period has been elapsed.

RESET MACHINE

- The automatic program of the wrapping machine is interrupted and a failure indication will be displayed on the FS 250 console, when the emergency stop is activated or any other failure is detected.
Wrapping can only be started again after pushing reset on the control panel. Thus, the failure is reset and the control voltage is activated again, assuming that the mains switch still has been switched on. The cause of the failure has to be solved first, of course.

By holding down the reset button for 3 seconds the wrapping machine can be brought back to the start conditions.
Thus, the turntable returns back to the zero position of the machine.
The filmwagen has to be brought back to zero position, by pushing the manual downwards button.

BASIC OPERATING INSTRUCTIONS



1 = Program selector

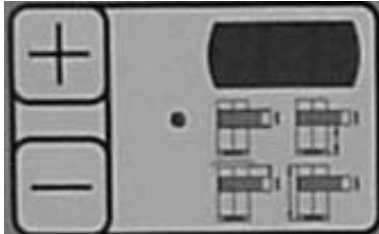

2 = Digital value-setting

Every time a wrapping selection is made by the selector, any adjustments that can be made on the type of wrapping itself, appears on the display

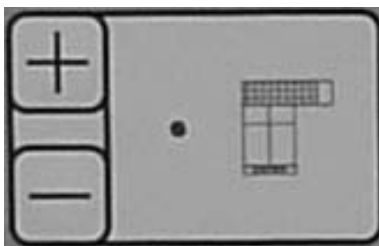

3 = Digital setting for adjustment of number topwraps (adjustment 0 to 10)

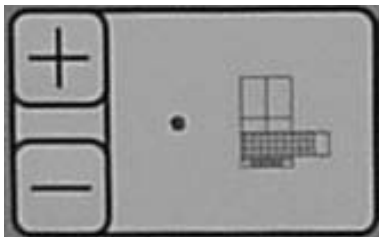

4 = Digital setting for adjustment of number bottomwraps (adjustment 0 to 10)



5 = Digital setting for adjusting film tension

Thus the film pré-stretch is fixed by means of the different gearings. By adjusting the film tension the customer can pré-stretch more or less. (Standard max 150%)

Note! The setting does not indicate a percentage of pré-stretch. This percentage is fixed by means of the gearings. The setting is only a value.



6 = Digital setting for adjusting carriage descent speed

BASIC OPERATING INSTRUCTIONS



7 = Digital setting for adjusting carriage ascent speed



8 = Digital setting for adjusting turning speed



9 = RESET button

Press 3 seconds to reset in Zero position



10 = Plate turning Jog function



11 = Carriage movement jog button

- press once and hold it down to raise the carriage
- press twice and hold it down to lower the carriage



12 = Carriage ascent / descent jog button



13 = Automatic topres active.

Thus when the topres is activated it will work during every programm

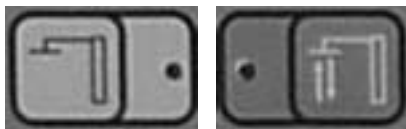

To lock or unlock the machine, to prefend or change the parameters for the programs. Push these 2 buttons together for 5 seconds.



14 = Manual topres function

BASIC OPERATING INSTRUCTIONS

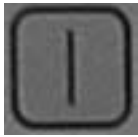

15 = START button

Automatic run mode with settable cycles

Activate this run mode, after the machine has been turned on and the safety conditions have been complied with, by pressing the START pushbutton provided that the corresponding work cycle has been set via the pushbutton panel.

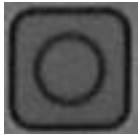

16 = Stop button

For stopping the machine so that it can restart from the operation point in which it stopped.

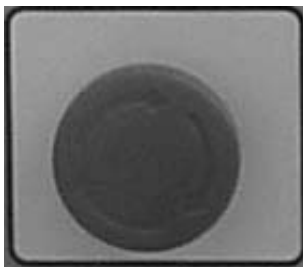

17 = EMERGENCY STOP

The control voltage for the total system disappears. The main power can be switched on again by deactivating the emergency stop, after having executed the necessary activities or having ascertained that no danger does exist any more for damage or injuries.

STARTING AND STOPPING OF A WRAPPING CYCLE

Automatic run mode with settable cycles

Activate this run mode, after the machine has been turned on and the safety conditions have been complied with, by pressing the START pushbutton provided that the corresponding work cycle has been set via the pushbutton panel.

ATT. The acoustic signal is active during approximately 3 seconds before the automatic wrapping cycle will be executed. The machine will only start to operate after this period has been elapsed.

N.B. The automatic wrapping cycle is only started, if the start conditions are fulfilled. A failure indication is displayed, if not all start conditions are fulfilled. The start conditions for the automatic wrapping cycle are:

- One of the WRAPPING PROGRAMS 1-7 should be selected;
- Photocell "pallet height" should be activated;
- Emergency stop not activated;
- No failure detected;

Stop with table deceleration

This stop is commanded as follows:

- by pressing the stop pushbutton
- by pressure exerted on the crush-proof guard
- by the presence of an alarm that commands the immediate stop.

This stop mode envisages:

- the immediate stop of the film carriage
- the turnplate starts to slow down until it stops.

NOTE: with this type of stop the machine can restart from the operating point in which it had stopped by, pressing the start button.

WRAPPING PROGRAMS

- 1. Single wrapping** After the pre-set number of bottom wraps has been completed, while the turntable is turning, the film carriage will go upwards. When the film carriage has arrived on top and the pre-set number of top wraps has been completed, the turntable will halt. The film can be cut now on top. After pushing start again the machine restarts with the descend only program.
- 2. Double wrapping** The complete (double) wrapping program will be executed with this function. After completing the pre-set number of bottom wraps the film carriage will go upwards, then it halts to lay the top wraps, while the turntable keeps turning, and then it will go downwards again. Another number of pre-set bottom wraps is laid, after which the turntable will halt. Now the film can be cut and the pallet can be transported.
- 3. Double wrapping + TS** After the pre-set number of bottom wraps has been completed, while the turntable is turning, the film carriage will go upwards. When the film carriage has arrived on top it first, lays approx. 1 top wrap, move downwards and wait until the topsheet has been laid, after pushing start the film carriage will go upwards again and wrapping in the topsheet, after this the film carriage will go downwards again. Another number of pre-set bottom wraps is laid, after which the turntable will halt. Now the film can be cut and the pallet can be transported
- 4. Stuffed wrapping** The complete (double) wrapping program will be executed with this function. After completing the pre-set number of bottom wraps the film carriage will go upwards. At a certain pre indicated height (adjusted with the parameters), the film carriage will halt and puts extra layers of film on the pallet then it halts to lay the top wraps, while the turntable keeps turning, then it will go downwards again. Another number of pre-set bottom wraps is laid, after which the turntable will halt. Now the film can be cut and the pallet can be transported
- 5. Pre set height** The complete (double) wrapping program will be executed with this function. The starting height of the film carriage can be adjusted by changing the parameters on the control cabinet. After pushing start the film carriage will go up until the pre-installed height. Then the film carriage will halt to give the opportunity to fix the stretchfilm to the pallet. After pushing start again the machine will complete the pre-set number of bottom wraps, the film carriage will go upwards. then it halts to lay the top wraps, while the turntable keeps turning, after this it will go downwards again. Another number of pre-set bottom wraps is laid, at the pre fixed starting height, after which the turntable will halt. Now the film can be cut and the pallet can be transported
- 6. Double wrapping disabling Fotocel** See program 2 with one exception. In this program you can pre set the pallet height with by changing the parameters on the control cabinet. This program is special made for goods which cannot be read by the photoelectric sensor.
- 7. Customprogram** The technical service department of the supplier of the machine is able to make a custom specific program by changing the parameters on the control board. In this way it is able to wrap quite every pallet of goods.
Note! This can only be done by the manufacturer of the machine.

ALARMS AND ERRORS

THE CARRIAGE DOES NOT STOP AT THE LOWER OR UPPER LIMIT STOP MICROSWITCH

The arrised problem

- Limit switches and not connected properly
- Limit switch malfunctioning
- Limit stop cam incorrectly positioned

Possible remedies

- Check the wiring
- Replace the limit switch
- Check for the position of the cams by adjusting the respective adjuster screws

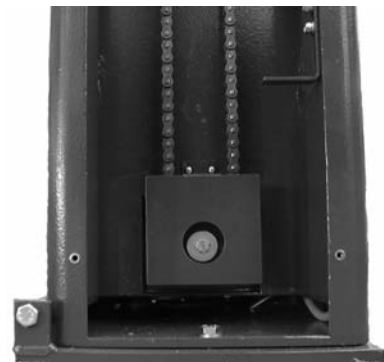

WHEN THE FILM TENSION VALUE IS INCREASED OR DIMINISHED, TENSION DOES NOT CHANGE

The arrised problem

- clutch not connected properly
- clutch not working

Possible remedies

- Check the connection
- Replace the clutch

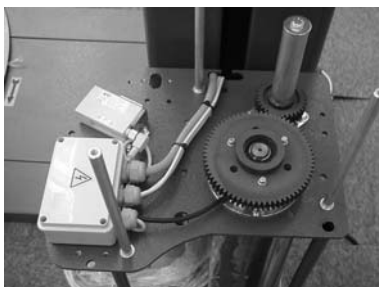

Should the problem persist, contact the Customer After-Sales Service of MANUFACTURER

THE MACHINE DOES NOT STOP WHEN THE EMERGENCY MUSHROOM-HEAD BUTTON IS PRESSED

The arrised problem

- emergency circuit failure
- emergency mushroom-head button not working

Possible remedies

- Check the circuit
- Replace the emergency mushroom-head button

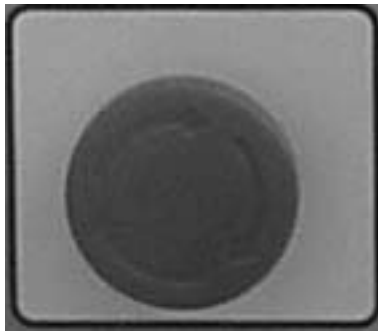

Should the problem persist, contact the Customer After-Sales Service of MANUFACTURER

THE TURNS AT THE BOTTOM AND AT THE TOP OF THE LOAD ARE NOT REGULATED PROPERLY

The arrised problem

- limit switches (1) not connected properly
- limit switch malfunctioning
- The control card (2) is not working properly

Possible remedies

- Check the wiring
- Replace the limit switch
- Replace the faulty card by carefully referring to the wiring diagram attached to the machine documentation

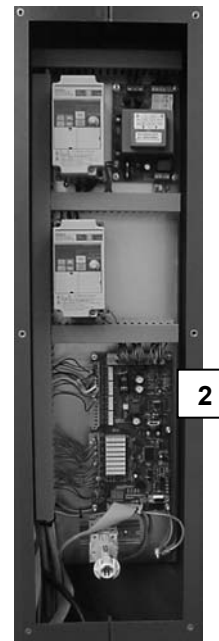
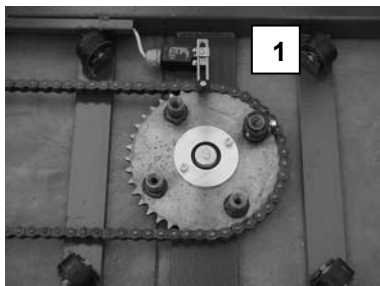

Should the problem persist, contact the Customer After-Sales Service of MANUFACTURER

ALARMS AND ERRORS

- AL 1 = Carriage emergency limit switch
- AL 2 = Main contactor
- AL 3 = Inverter overload
- AL 4 = Transpallet sensor
- AL 5 = Film tearing alarm (optional)
- AL 6 = Encoder sensor
- AL 7 = Toppres sensor

ALARM RESET

After having cleared the fault, push the **RESET** button

AL1 CARRIAGE EMERGENCY LIMIT SWITCH**The arised problem**

- This alarm signals that exerted pressure on the carriage has been detected by the microswitch that interlocks the crush-proof guard
- Microswitch incorrectly positioned or connected
- Microswitch not working properly

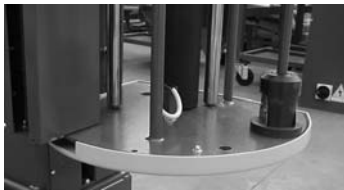
**Possible remedies**

- Check the situation
- Position the microswitch correctly
- Replace the microswitch

Should the problem persist, contact the Customer After-Sales Service of MANUFACTURER

AL2 MAIN CONTACTOR**The arised problem**

- This alarm signals that the emergency button was pressed
- Emergency button not working properly

Possible remedies

- Check the situation and deactivate the mushroom-head button
- Replace the emergency button

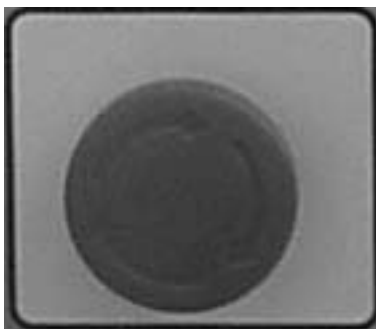

Should the problem persist, contact the Customer After-Sales Service of MANUFACTURER

AL 3 INVERTER FAULT

The arrised problem

- This alarm signals the blocking of an inverter

- Inverter not working properly

Possible remedies

- Turn off the machine. Wait 20 seconds and turn it on again.
- If the problem persists:**
- Check the situation on the display of the inverter referring to the inverter instruction manual that is enclosed with the machine documentation
- Check for the presence of mechanical motor locks, if any, and proceed as required
- Replace the inverter



Should the problem persist, contact the Customer After-Sales Service of MANUFACTURER

AI 4 TRANSPALLET

The arrised problem

- Phonic wheel sensor incorrectly positioned

- Sensor not connected properly

Possible remedies

- Check for the correct positioning of the sensor as compared to the phonic wheel
The distance should not be more than 2mm
- Check for the correct connection of the sensor by means of the associated connector
- Replace the sensor

Should the problem persist, contact the Customer After-Sales Service of MANUFACTURER

AL 5 FILM TEARING ALARM (Option 16.8242)

The arrised problem

This alarm indicates that the non-work time set for the rubber pin (1) has elapsed due to:

- Film roll finished
- Film tearing
 - Card (2) not working

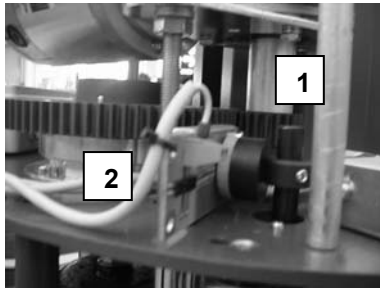

Possible remedies

- Replace the roll
- Restore the film
- Replace the card

Should the problem persist, contact the Customer After-Sales Service of MANUFACTURER

COUNT SENSOR FOR CARRIAGE PHONIC WHEEL

The arrised problem

- Phonic wheel sensor incorrectly positioned
- Sensor not connected properly
- Sensor not working properly

Possible remedies

- Check for the correct positioning of the sensor as compared to the phonic wheel
The distance should not be more than 2mm
- Check for the correct connection of the sensor by means of the associated connector
- Replace the sensor

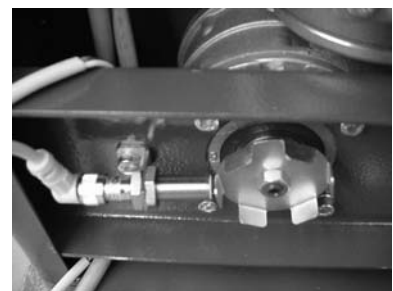
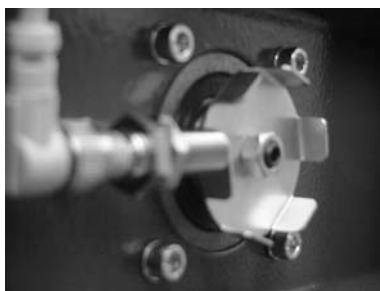

Should the problem persist, contact the Customer After-Sales Service of MANUFACTURER

INSERTING THE FILM

Place the new film reel (direction of unwinding depends on the side on which the cling is found).

Guide the film through the brake system according to the subjoined drawing.

Arrows on the inside of the rol means:**CI = CLING INSIDE**

The film has to be guided through the brake system in this way when applying a "differential cling"-film with the cling on the inside of the film when unwinding the film from the film reel.

Arrows on the outside of the rol means:**CO = CLING OUTSIDE**

The film has to be guided through the brake system in this way when applying a "differential cling"-film with the cling on the outside of the film when unwinding the film from the film reel.

The way of guiding the film through the brake system when applying a "double sided cling"-film is basically not relevant.

Stretchfilm

- LLDPE Material	Max 35 μ / 0,000138"
- Spool core diameter	76,2 mm / 3"
- Outer diameter of spool	Max. 250 mm
- Film width	Max. 500 mm

MAINTENANCE INSTRUCTIONS FOR OPERATORS

SAFETY!

- First switch off the main switch and lock it before carrying out maintenance on the installation.
- Take care, that other persons cannot put the installation in action.
- Take care, that the protection covers, etc. are remounted when putting the installation in action again.

The installation will have a long operational life due to preventive maintenance. This means, that the various parts of the installation have to be monitored on a weekly, monthly, semi-annually or annually schedule.

The operational lifetime is influenced by the environmental conditions. The indicated maintenance frequency is valid for normal operation conditions (8 hrs per day, 20° C, clean environment). One is advised to increase the maintenance frequency under more severe conditions. Keep rotating parts free from dirt.

REMAINDER OF THE FILM

The machine has to be cleaned every day

Never use solvents to clean the machine. To remove dust or particles deposited during the size changeover operations, never use compressed air: only use rags and aspirators.

Check if any film and packaging remainder are present in the brake system and remove it.

Weekly maintenance

- Check that the shaft chain is taut by means of the chain tightener
- Check the tension of the chain that moves the turnplate; if need be adjust the chain tightener by means of the screws



Monthly maintenance

- grease the shaft chain and the corresponding slide guides
- grease the chain that moves the turnplate



Yearly maintenance

Check the wear condition of the sliding wheels of the turnplate :

- Insert the lifting eyebolts into the specific threaded holes and release the turnplate by regulating the four screws
- Insert the hooks of the lifting ropes into the eyebolts
- Lift the turnplate using suitable load bearing lifting equipment
- Check the wear condition of the wheels and replace them if required (insert them by pressing them in place)
- Secure the turnplate carefully



Special maintenance (Replacing parts)

Replacing carriage drive chain

- loosen the chain by unscrewing the screw of the corresponding chain tightener
- unscrew the screw that fastens the chain to the drive carriage to remove the chain.



Replacing the turnplate drive chain

- lift the turnplate
- loosen the chain by unscrewing the screw of the corresponding chain tightener
- unscrew the screw that fastens the chain to the drive carriage to remove the chain.



Locating the cams that adjust the stroke of the limit stop. Activating the microswitches of the carriage

In order to perform any positioning modifications of the limit stop, adjust the cams, by regulating the corresponding adjuster screws

Adjust the cams downwards: The microswitches of the carriage will be activated at a lower level of the pallet

Adjust the cams upwards: The microswitches of the carriage will be activated at a higher level of the pallet

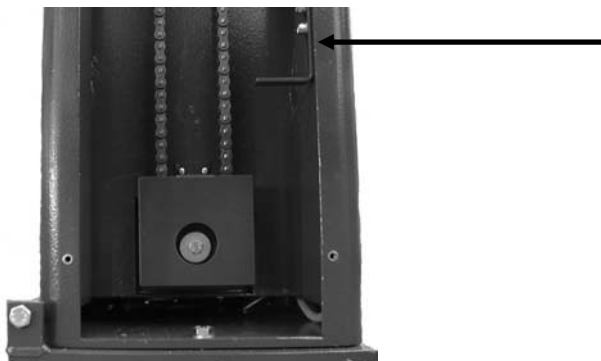

MAINTENANCE SCHEME

MAINTENANCE FREQUENCY							
	8 hr	40 hr	100 hr	200 hr	500 hr	1000 hr	2000 hr
Daily cleaning	X						
Cleaning eye of photocell			X				
Shaft chain				4			
Turnplate chain				4			
Gear wheels				4			
Bearings						X	
Friction discs						X	
Proximity and limit switches						X	
Electrical system							X
Sliding wheels							X
Support wheels							X

The numbers in the maintenance scheme refer to lubricants, which are to be applied in the table with lubricants (hereunder).

The symbol "X" in the maintenance scheme refers to remarks concerning the maintenance of or checking on the relevant part or system.

LUBRIFICANTS

No.	LUBRIFICANT					
	SHELL	BP	ESSO	MOBIL OIL	TEXACO	
1	OMALA 220	ENERGOL GR-XP 220	SPARTAN EP 220	MOBILGEAR 630	MEROPA 220	
2	OMALA 680	ENERGOL GR-XP 680	SPARTAN EP 680	MOBILGEAR 636	MEROPA 680	
3	TONNA T68	MACCURAT 68	FEBIS K 68 EP220	VACTA.4	WAX LUBRICANT X68	
4	ALVANIA R	ENERGREASE L2	BEACON 2	MOBILUX 2	MULTIFAK EP2	
5	TELLUS 46	HPL 46	NUTCO H46	DTE 26	RANDO HD46	
6	TORCULA 32	ENERGOL RD-E 80	AROX EP 56	ALMOBIL 1	ARIES 32	
7	TELLUS 15				RANDO HDZ 15	
8	RETINAX WB				STARPLEX PREMIUM 1 (depending on the application)	
9						