

FROMM

**ELS FS390 FROMM
TURNTABLE STRETCH MACHINE
Carriage 1 motor
WITH OPTION TOP-PRESS
ELS.1137
Version 02 machines**

Print date _ Wednesday 19 October 2022/ © 10/22

PROGETTO
BANCA DIS.
TIPICO

Copyng of this document, and giving it to other and the use or communication of the contents thereof, are forbidden without express authority. Offenders are liable to the payment of damages. All rights are reserved in the event of the grant of a patent or the registration of a utility model or design.

MODEL : FROMM FS 390 WITH TOP PRESS

Carriage with one motor and gear ratio

KIND OF CIRCUIT	COLORS CONDUCTORS	MINIMUM SECTION	F			
			DATA	17/10/2022	FROMM	
POWER CONDUCTORS AC	BLACK	N07V-K/1,5mm ²	DATE	17/10/2022	FILE : ELS.1137.dwg	
NEUTRAL CONDUCTORS	LIGHT BLUE	N07V-K/1,5mm ²	DISEGN.	SCIENZA S.	ELS.1137	
POWER CONDUCTORS DC	GRAY	N07V-K/0,75mm ²	VISTO		FS390 with top press	
CONTROLS / SIGNALS DIRECTING CURRENT	BLUE	N07V-K/0,75mm ²	APPR.		Carriage with one motor and gear ratio	
GROUND CONDUCTORS	YELLOW-GREEN	N07V-K/1,5mm ²			FG. 01	
					F.S. 02	
					F.T. 14	
					F	

TENSIONE
POWER SUPPLY

230V ac

POTENZA INSTALLATA
INSTALLED POWER

1kW

CORRENTE
CURRENT

4A

FROMM

FROMM ITALIANA S.r.l.
Caprino Veronese (VR)
ITALY

ELS.1137

FOGLIO

1

T.F. 14

FILE : ELS.1137.dwg

REV. MODIFICA DATA FIRMA

SOST. IL :

SOST. DA :

FILE : ELS.1137.dwg

0

1

2

3

4

5

6

7

8

9

A

B

C

D

E

F

A

B

C

D

E

F

0

1

2

3

4

5

6

7

8

9

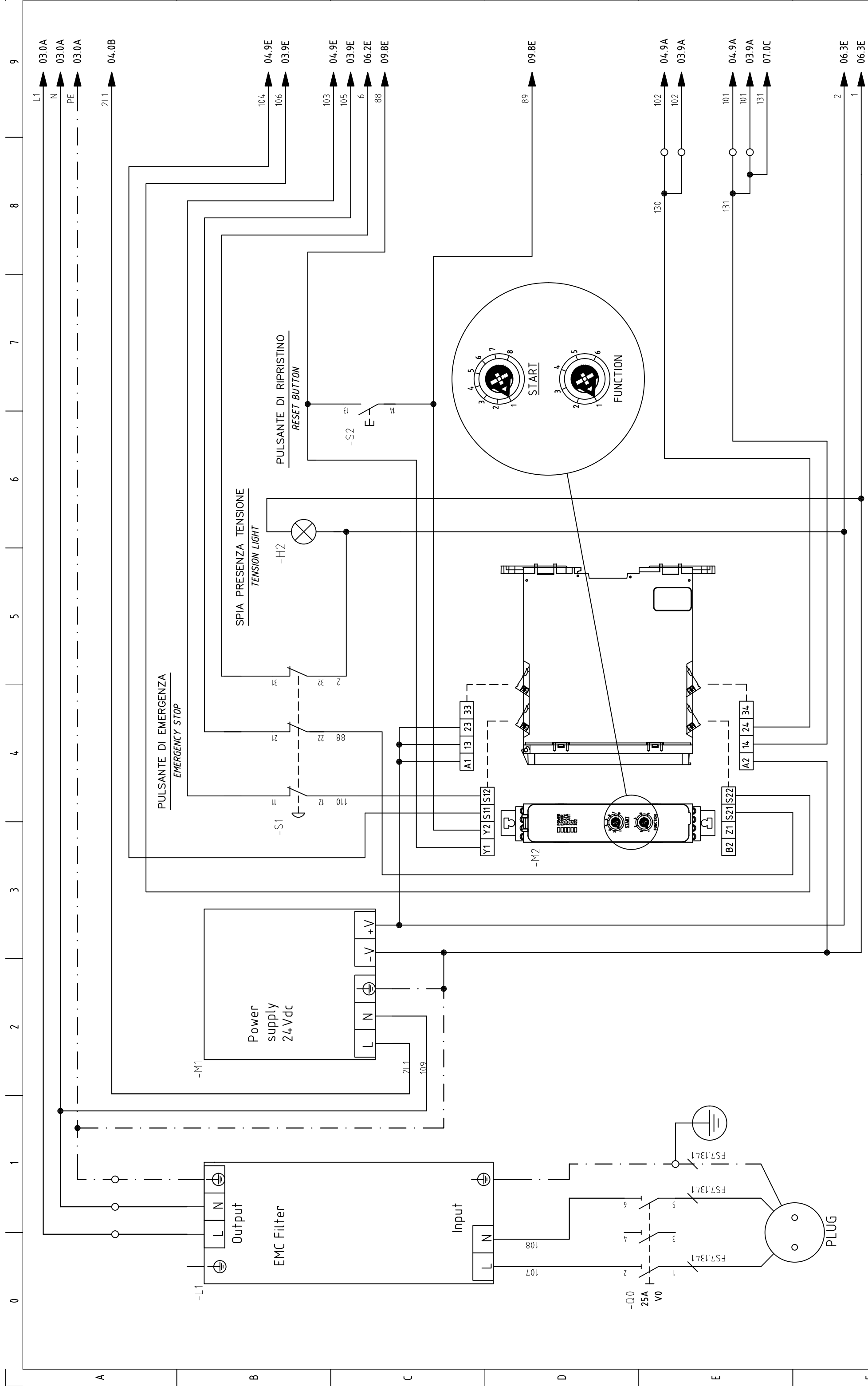

REV.	MODIFICA	DATA	FIRMA	APPR.	VISTO	DESIGN.	SCIENZA S.	DATA	17/10/2022
SOST. IL :				SOST. DA :			FILE : ELS.1137.dwg		

Carriage with one motor and gear ratio								
FS390 with top press								
ELS.1137								
=								
+								
FG. 02	F.S. 03							
F.T. 14	F.T. 14							

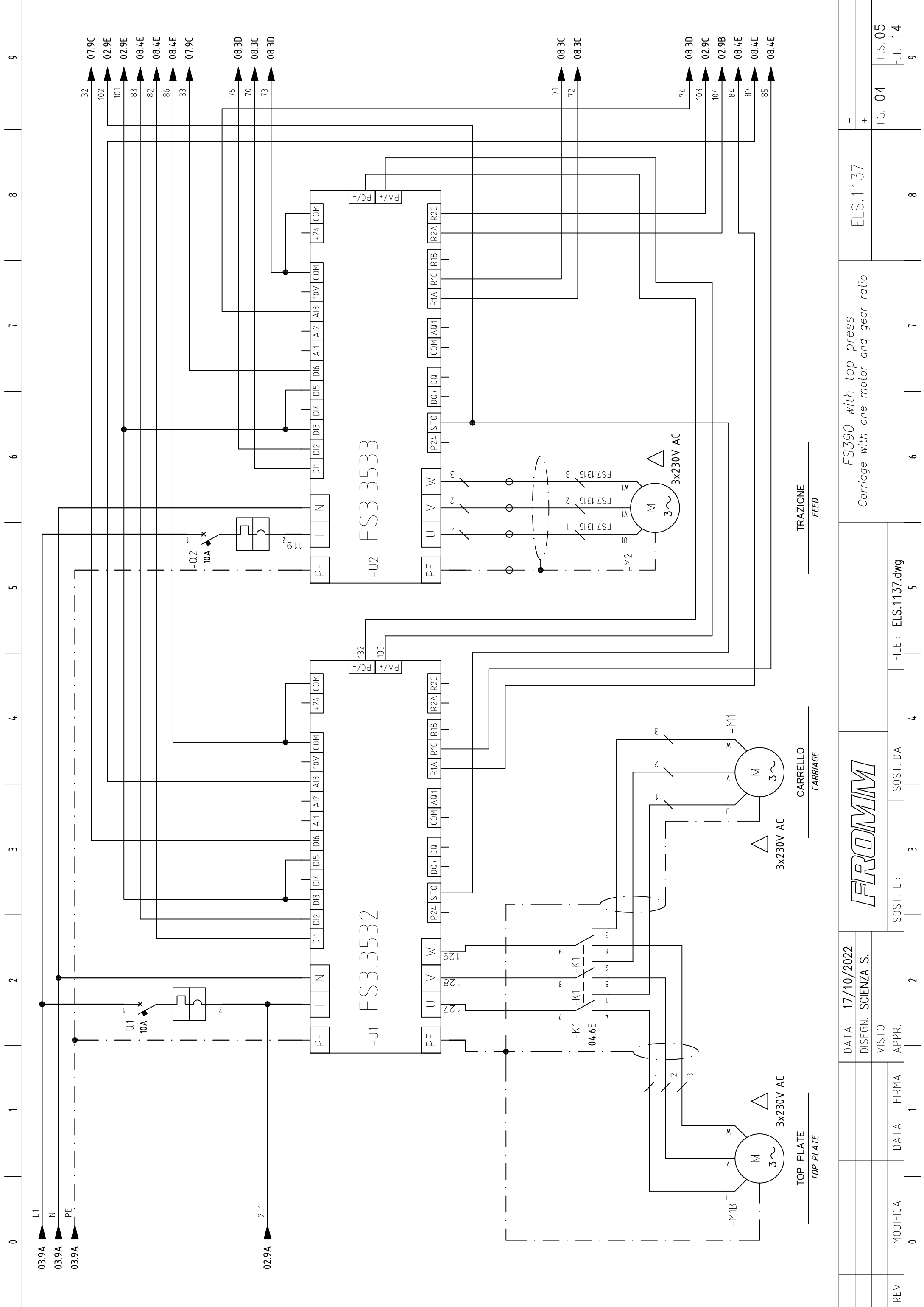

03.9A L1
 03.9A N
 03.9A PE
 02.9A 2L1

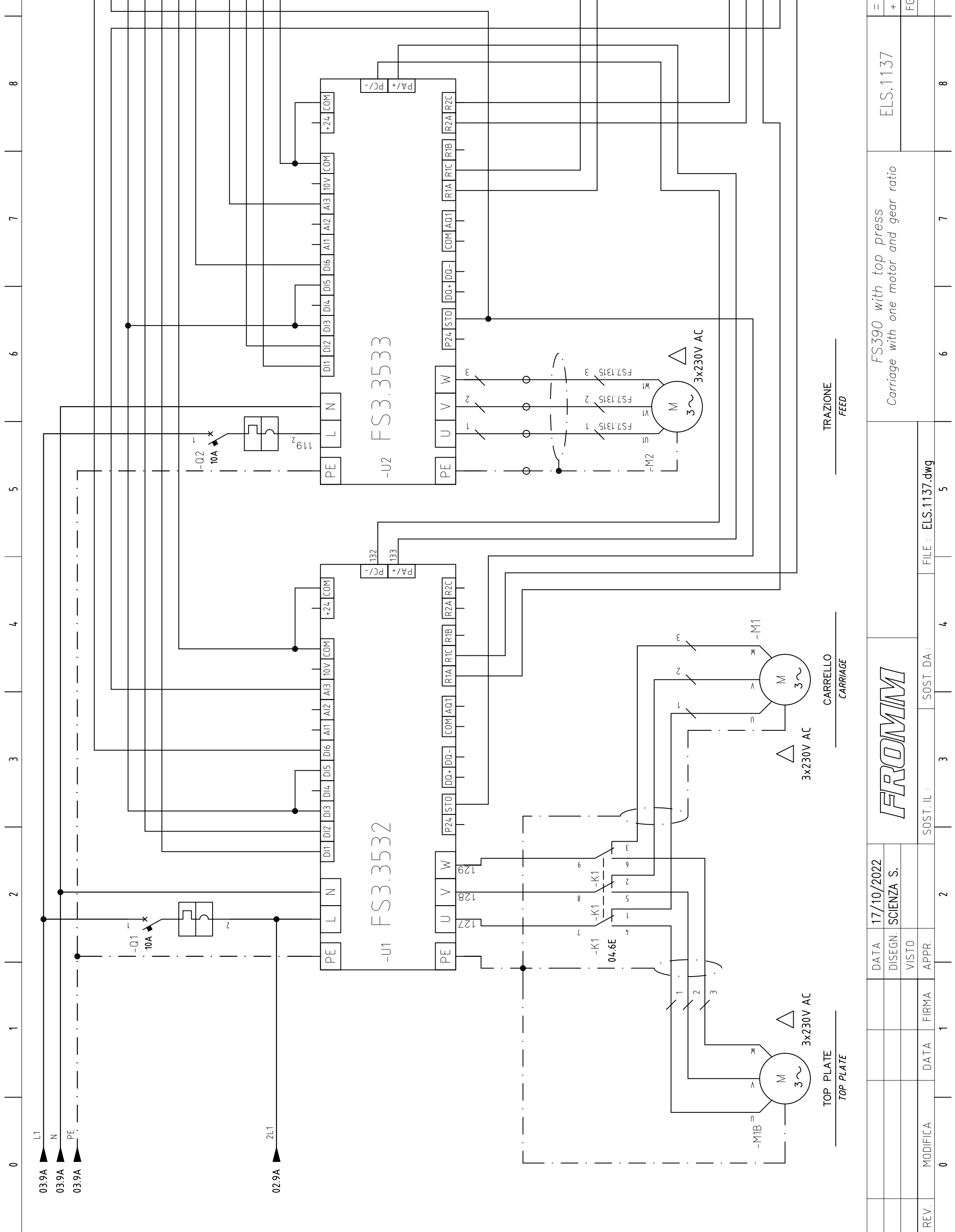

07.9C
 02.9E
 02.9E
 08.4E
 08.4E
 08.4E
 07.9C
 08.3D
 08.3C
 08.3D
 08.3C
 08.3C
 08.3D
 02.9C
 02.9B
 08.4E
 08.4E
 08.4E

REV.	MODIFICA	DATA	FIRMA	APPR.	SOST. IL :	SOST. DA :	FILE : ELS.1137.dwg
					3	4	5
					6	7	8
					9		
FS390 with top press Carriage with one motor and gear ratio							
ELS.1137							
							=
							+
							FG. 04
							F.S. 05
							F.T. 14

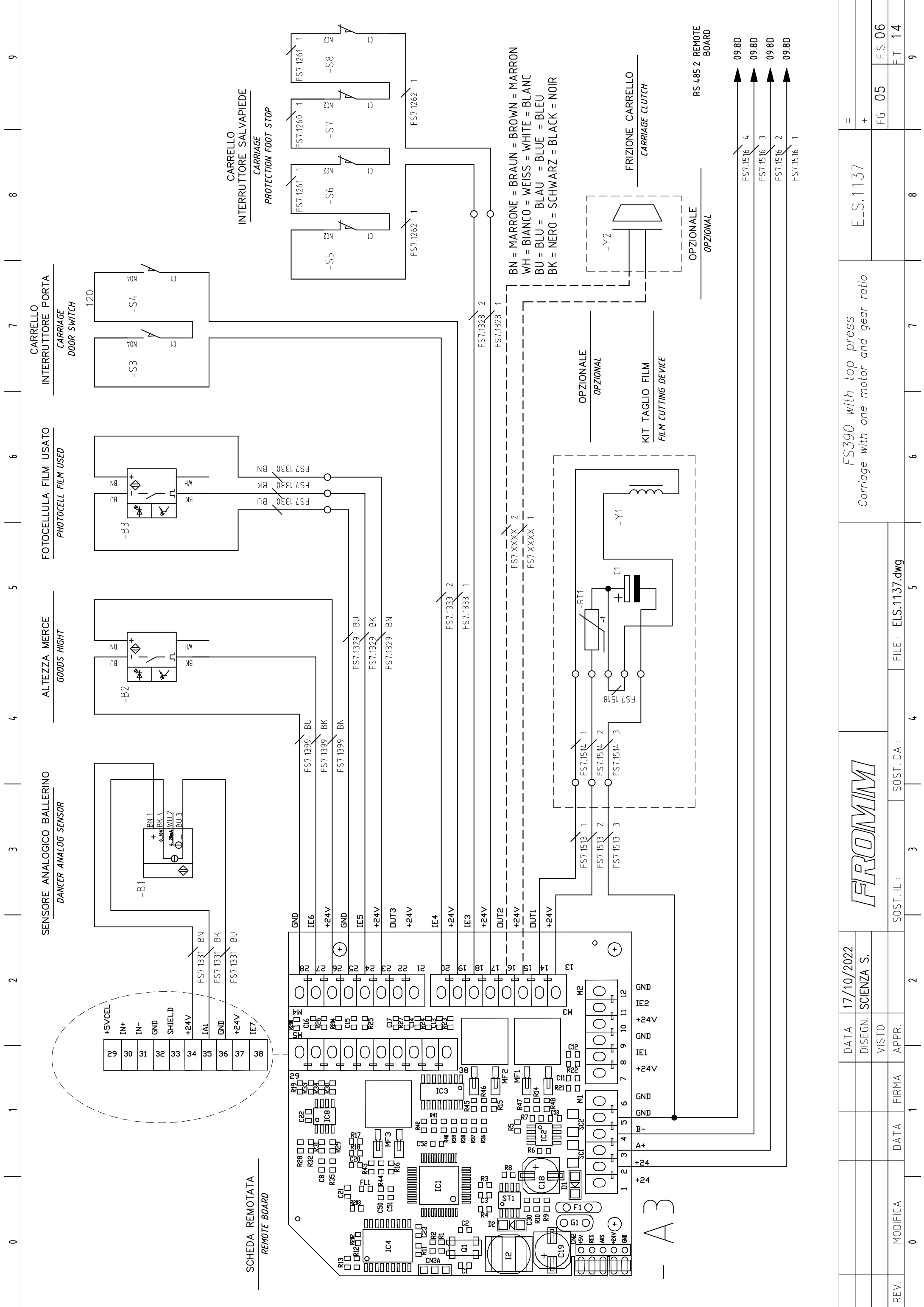

SENSORE ANALOGICO BALLERINO
DANCER ANALOG SENSOR

ALTEZZA MERCE
GOODS HIGHT

FOTOCPELLULA FILM USATO
PHOTOCELL FILM USED

CARRELLO
INTERRUTTORE PORTA
CARRIAGE
DOOR SWITCH

CARRELLO
INTERRUTTORE SALVAPIEDE
CARRIAGE
PROTECTION FOOT STOP

SCHEDA REMOTATA
REMOTE BOARD

BN = MARRONE = BRAUN = BROWN = MARRON
WH = BIANCO = WEISS = WHITE = BLANC
BU = BLU = BLAU = BLUE = BLEU
BK = NERO = SCHWARZ = BLACK = NOIR

FRIZIONE CARRELLO
CARRIAGE CLUTCH

RS 485 2 REMOTE BOARD

- A3

REV.	MODIFICA	DATA	FIRMA	APPR.	SOST. IL :	SOST. DA :	FILE :	ELS.1137.dwg
					3	4	5	
					6	7	8	9
FS390 with top press Carriage with one motor and gear ratio								ELS.1137
								=
								+
								FG. 05
								F.S. 06
								F.T. 14

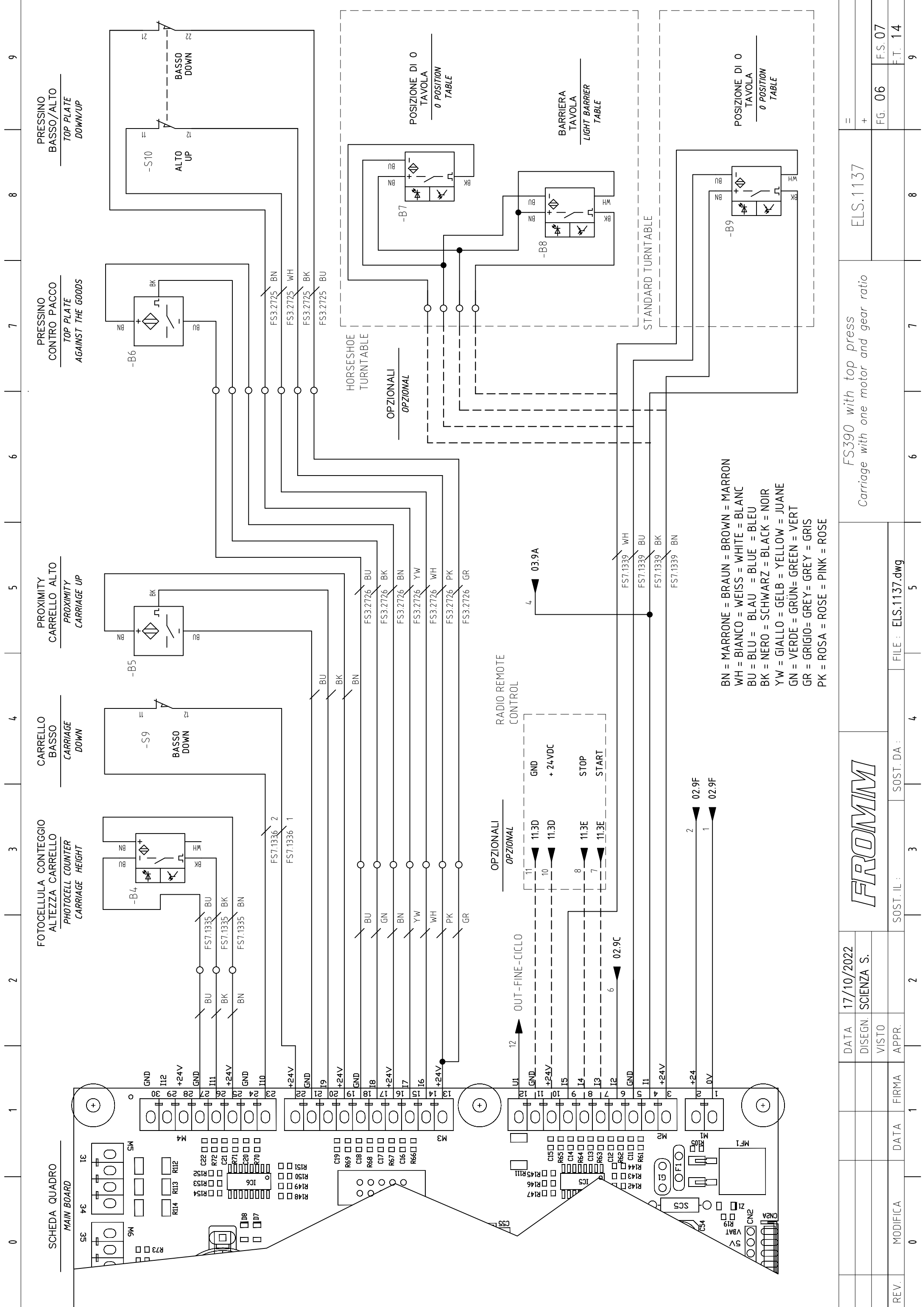

REV.	MODIFICA	DATA	FIRMA	APPR.	VISTO	DISEGN.	SCENZA S.	DATA	17/10/2022
				SOST. IL :				SOST. DA :	
				FILE :				ELS.1137.dwg	
FS390 with top press									
Carriage with one motor and gear ratio									
ELS.1137									
			FG. 06		F.S. 07				
			F.T. 14		F.T. 14				

0 1 2 3 4 5 6 7 8 9

A

B

C

D

E

F

MICROINTERRUTTORE
SICUREZZA CINGHIA
MICRO SWITCH
SAFETY BELT

LAMPEGGIANTE
FLASHING LIGHT

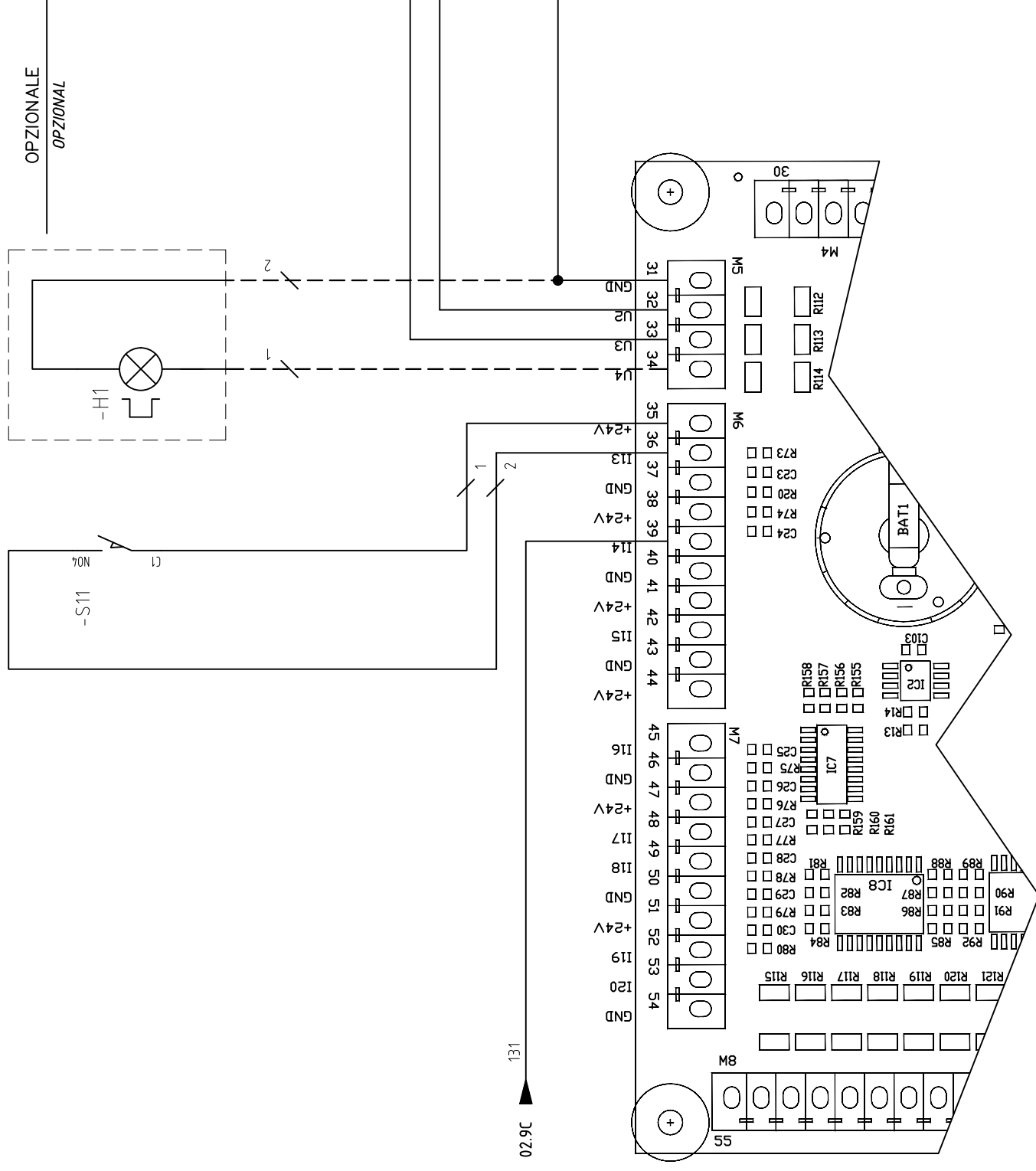

SCHEDA QUADRO
MAIN BOARD

04.9B
03.9B
04.9A

33

33

32

32

31

02.9C

131

ELS.1137

FS390 with top press
Carriage with one motor and gear ratio

FILE : ELS.1137.dwg

FROMMM

DATA 17/10/2022

DESIGN. SCIENZA S.

VISTO

APPR.

FIRMA

DATA

MODIFICA

REV.

0

1

2

3

4

5

6

7

8

9

=

+

FG. 07

F.S. 08

F.T. 14

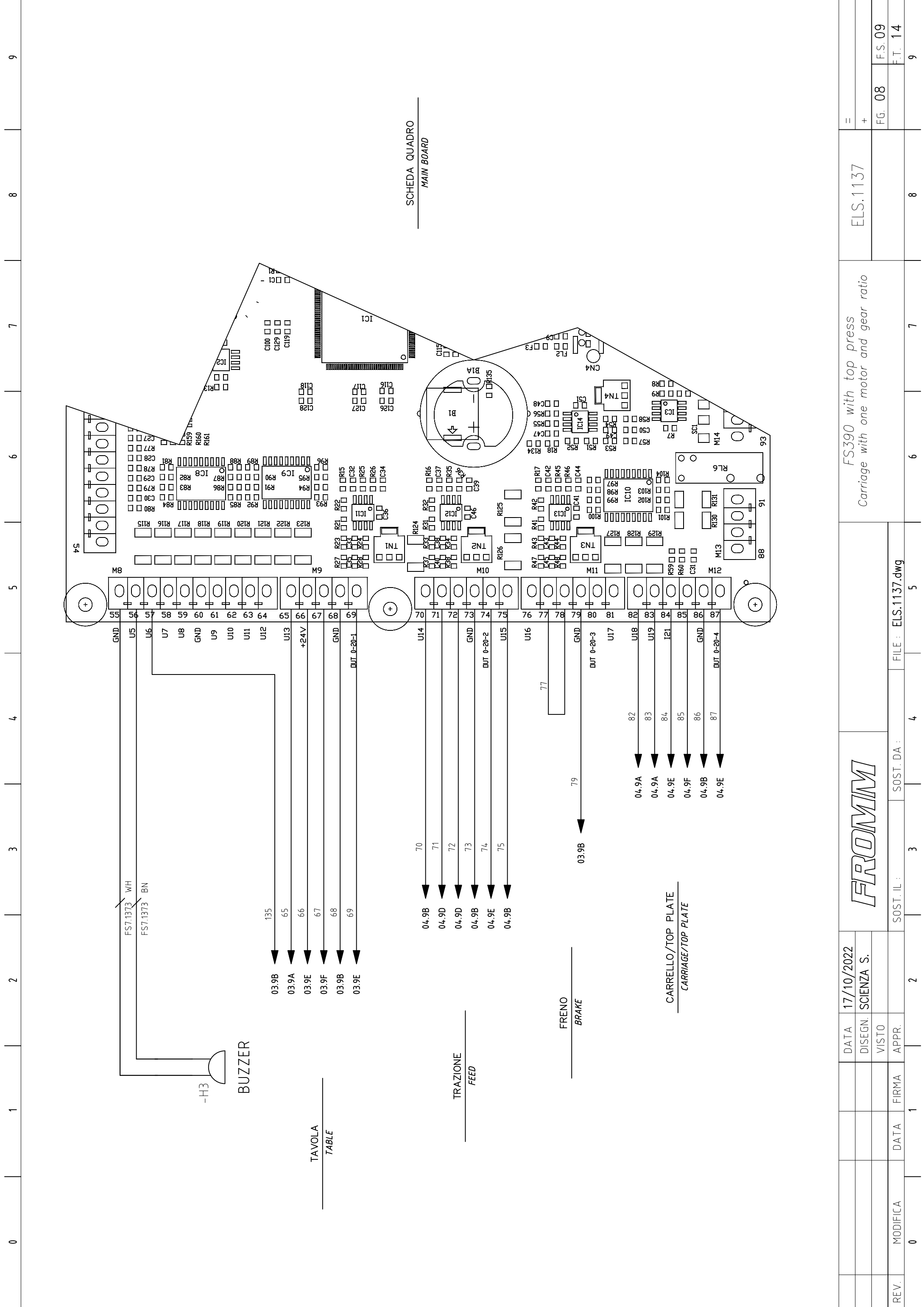

SCHEDA QUADRO
MAIN BOARD

-H3
BUZZER

TAVOLA
TABLE

TRAZIONE
FEED

FRENO
BRAKE

CARRELLO/TOP PLATE
CARRIAGE/TOP PLATE

FROMM

DATA 17/10/2022
DISEGN. SCIENZA S.
VISTO
APPR.

REV. MODIFICA DATA FIRMA

SOST. IL :

SOST. DA :

FILE : ELS.1137.dwg

FS390 with top press
Carriage with one motor and gear ratio

ELS.1137

=
+

FG. 08 F.S. 09
F.T. 14

0	1	2	3	4	5	6	7	8	9
A	B	C	D	E	F				

SCHEDA QUADRO
MAIN BOARD

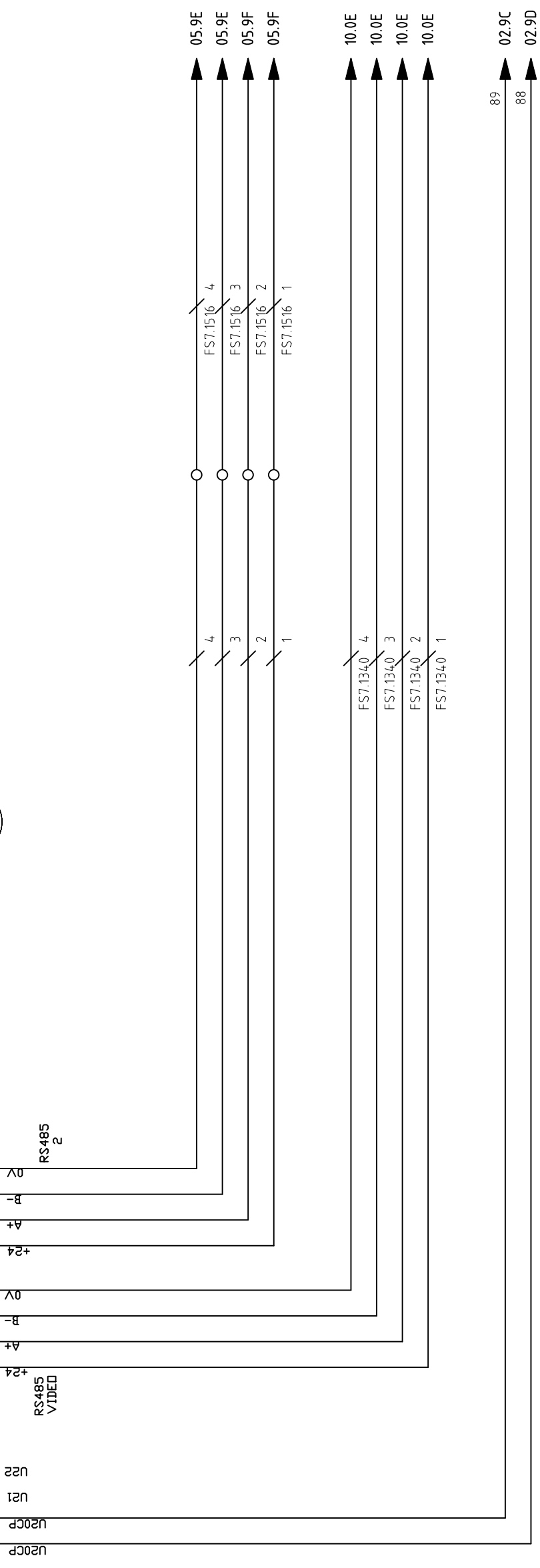
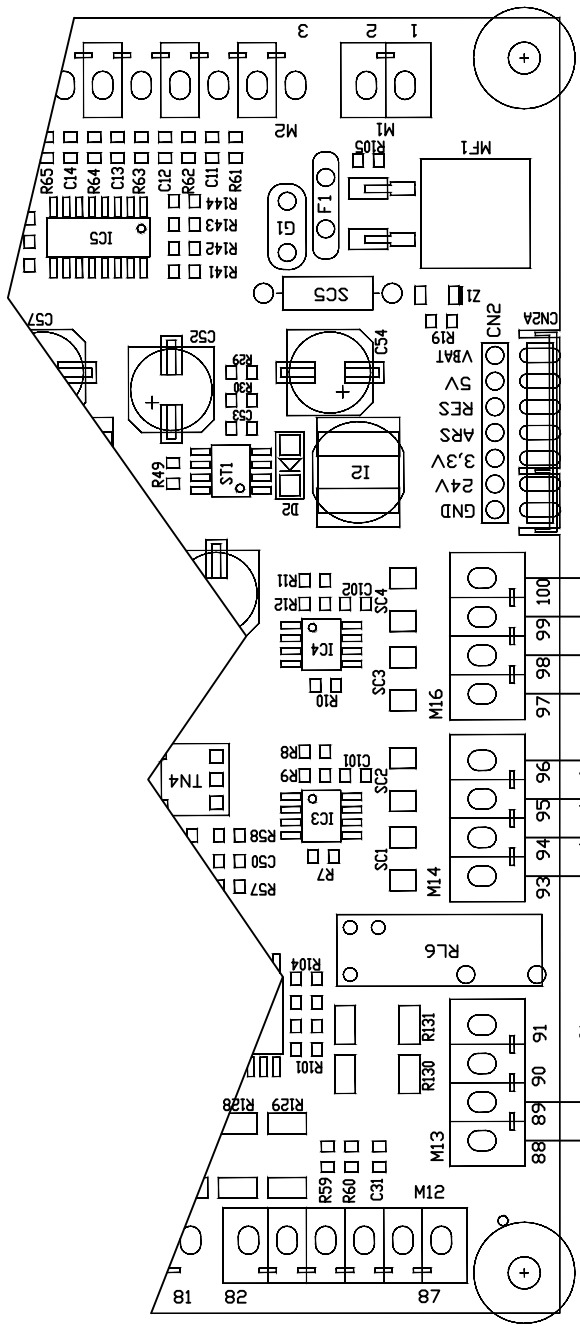

REV.	MODIFICA	DATA	FIRMA	APPR.	VISTO	DISEGN.	17/10/2022	DATA				FS390 with top press Carriage with one motor and gear ratio			ELS.1137			=							
																		+			FG. 09			F.S. 10	
									SOST. IL :	SOST. DA :	FILE :	ELS.1137.dwg	0	1	2	3	4	5	6	7	8	9	F.T. 14		

RADIO REMOTE
CONTROL

OPZIONALI
OPZIONAL

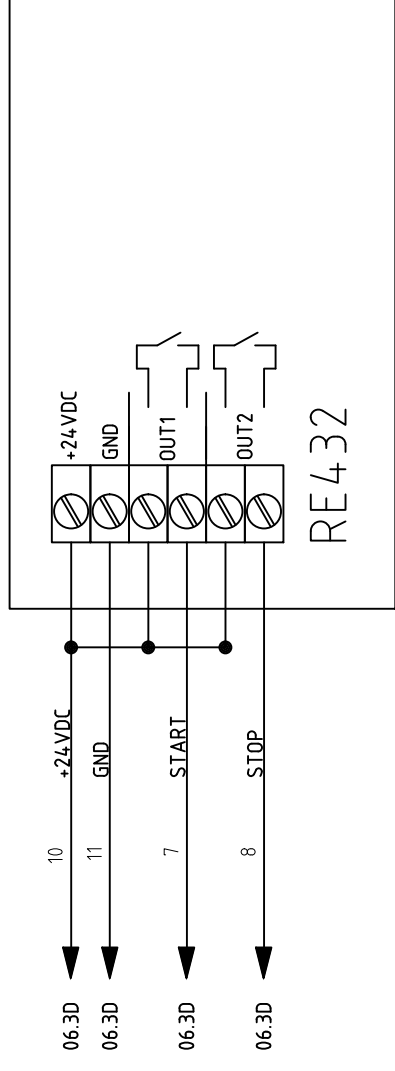

DATA 17/10/2022

DISEGN. SCIENZA S.

VISTO

APPR.

DATA FIRMA

MODIFICA

REV.

FROMM

SOST. IL :

SOST. DA :

FILE : ELS.1137.dwg

FS390 with top press
Carriage with one motor and gear ratio

ELS.1137

=

+

FG. 11

F.S. 12

F.T. 14

0 1 2 3 4 5 6 7 8 9

A

B

C

D

E

F

TASTIERA
KEYBOARD

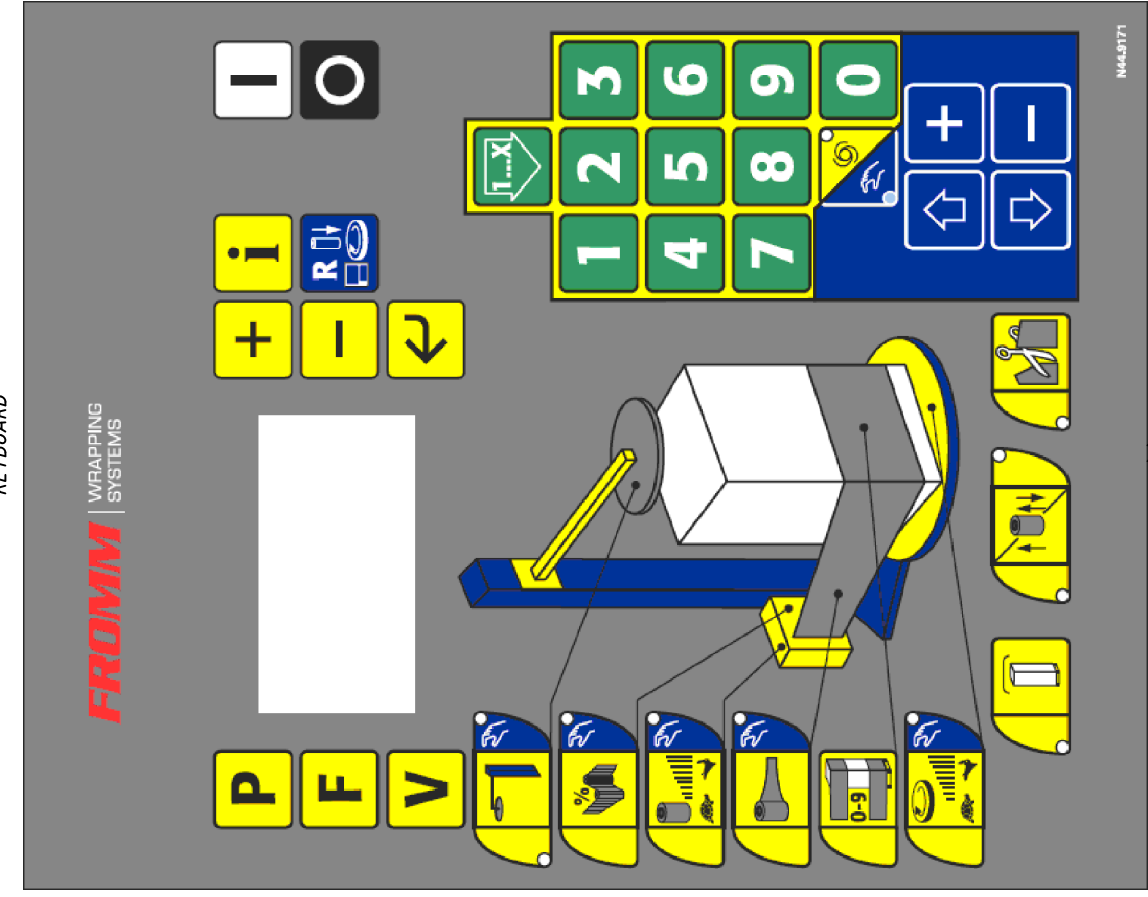

N44.9171

+

N52.7101

SCHEDA QUADRO
MAIN BOARD

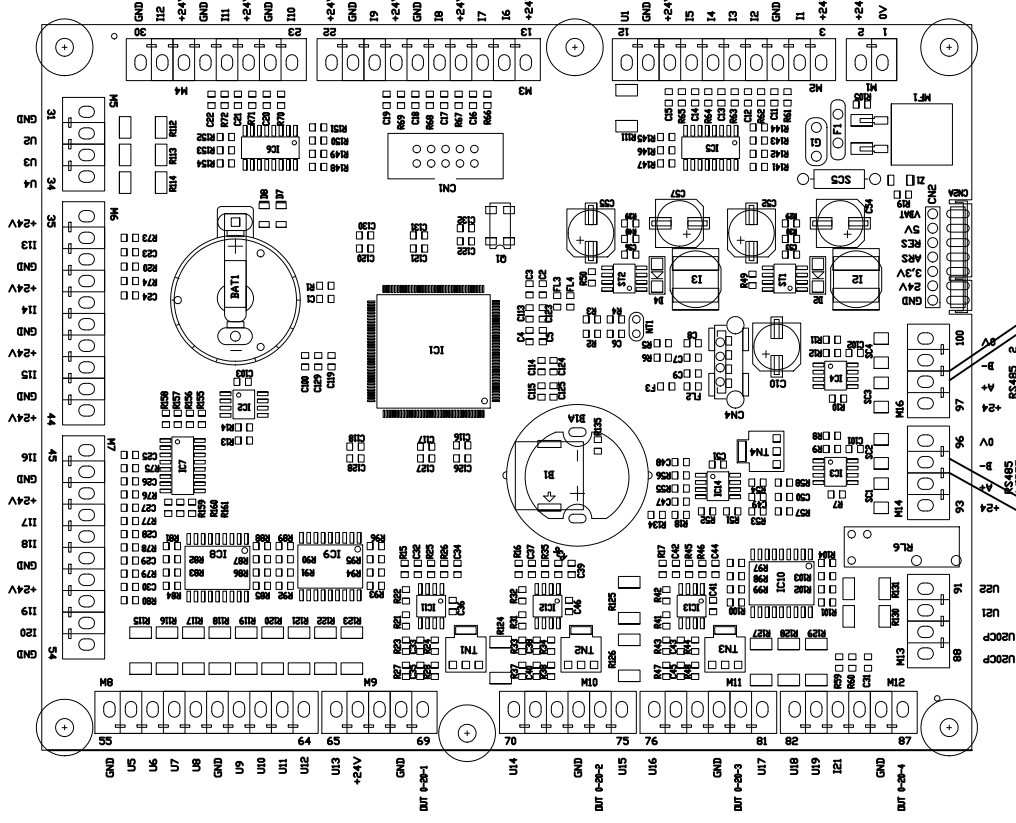

N51.7199

SCHEDA REMOTATA
REMOTE BOARD

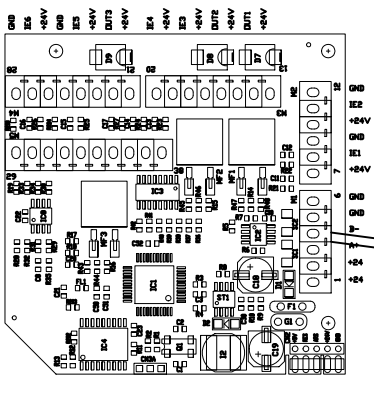

N52.7102

FS7.1516

FS7.1340

FS7.1517

(height column 2250, 2500mm)

OF

FS7.1507

(height column 2800, 3050mm)

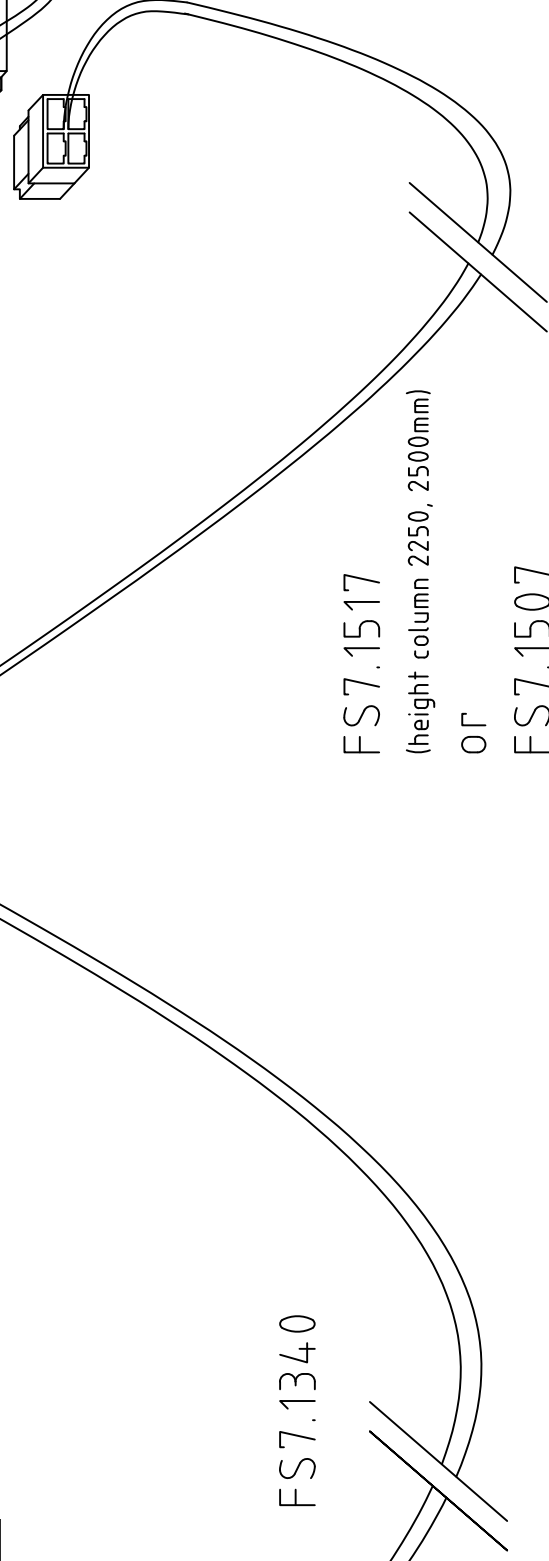

DATA 17/10/2022

DESIGN. SCIENZA S.

VISTO

APPR.

MODIFICA

DATA

FIRMA

1

2

3

4

5

6

7

8

9

FROMM

FS390 with top press
Carriage with one motor and gear ratio

ELS.1137

=

+

FG. 12

F.S. 13

F.T. 14

9

FILE : ELS.1137.dwg

SOST. IL : SOST. DA :

29	+5VCEL
	IN+
	IN-
	GND
	SHIELD
	+24V
	IA1
	GND
	+24V
38	IE7

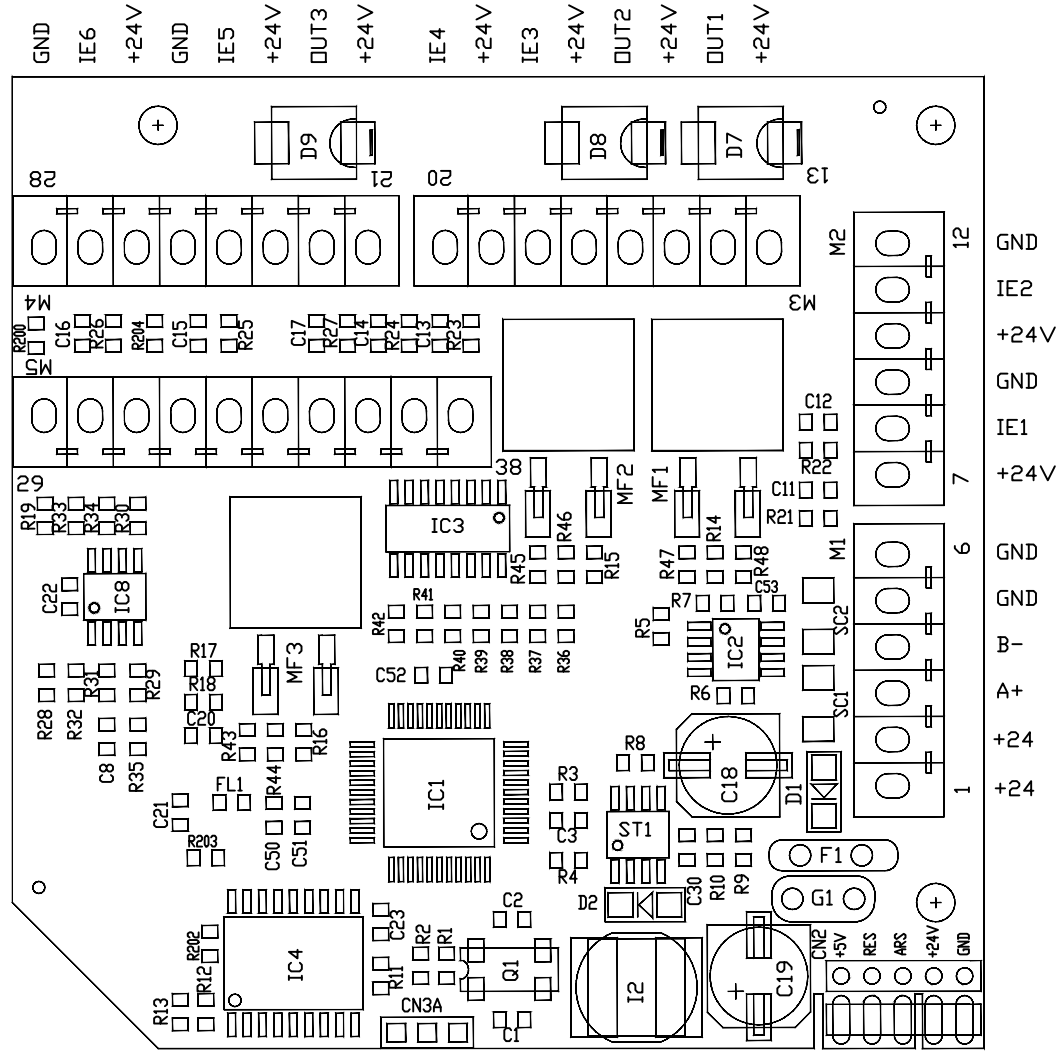

DATA 17/10/2022

DISEGN. SCIENZA S.

VISTO

APPR.



SOST. IL :

SOST. DA :

FILE : ELS.1137.dwg

FS390 with top press
Carriage with one motor and gear ratio

ELS.1137

=

+

FG. 14

F.S. 01

F.T. 14

A

B

C

D

E

F

0 1 2 3 4 5 6 7 8 9

0 1 2 3 4 5 6 7 8 9